



DELUSION INTERIO

DESIGN | DECOR | DETAIL

CLIENT-MR.RAJAT AHUJA

PROJECT-RESIDENTIAL

FRONT ELEVATION



SIDE ELEVATION





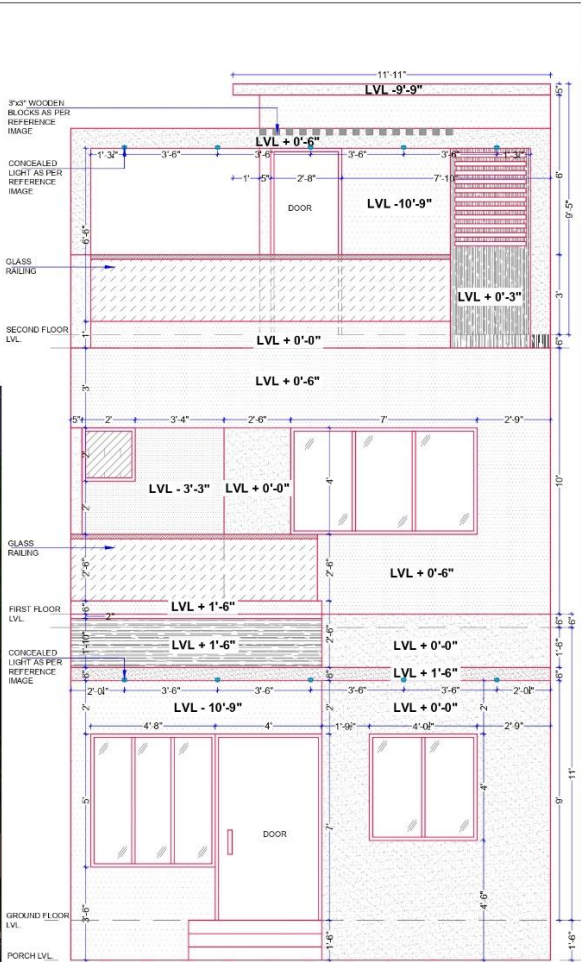

REFERENCE IMAGE



FRONT ELEVATION

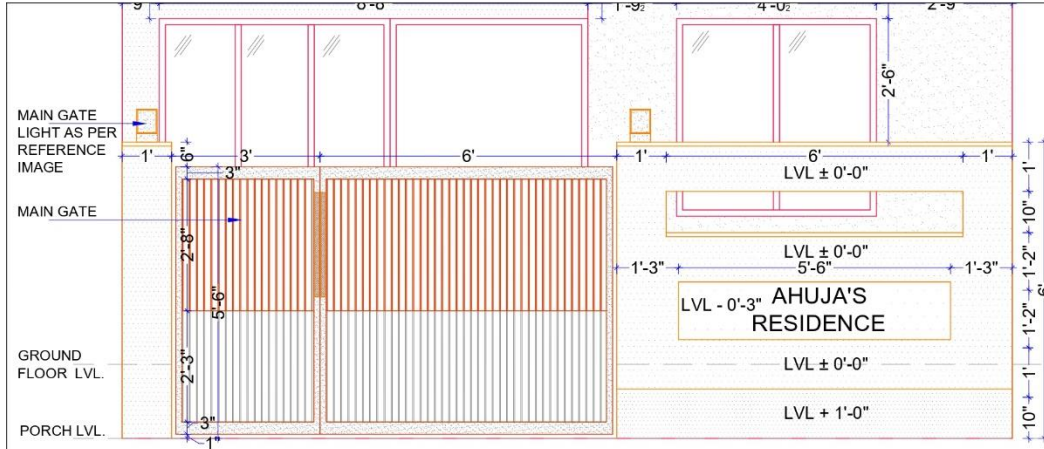

 DELUSION INTERIO	DELUSION INTERIO PVT. LTD., GMS ROAD, DEHRADUN			
	CLIENT NAME: Mr. Rajat Ahuja	PROJECT: Proposed Residence	PROPORTION: NOT TO SCALE	





FRONT ELEVATION



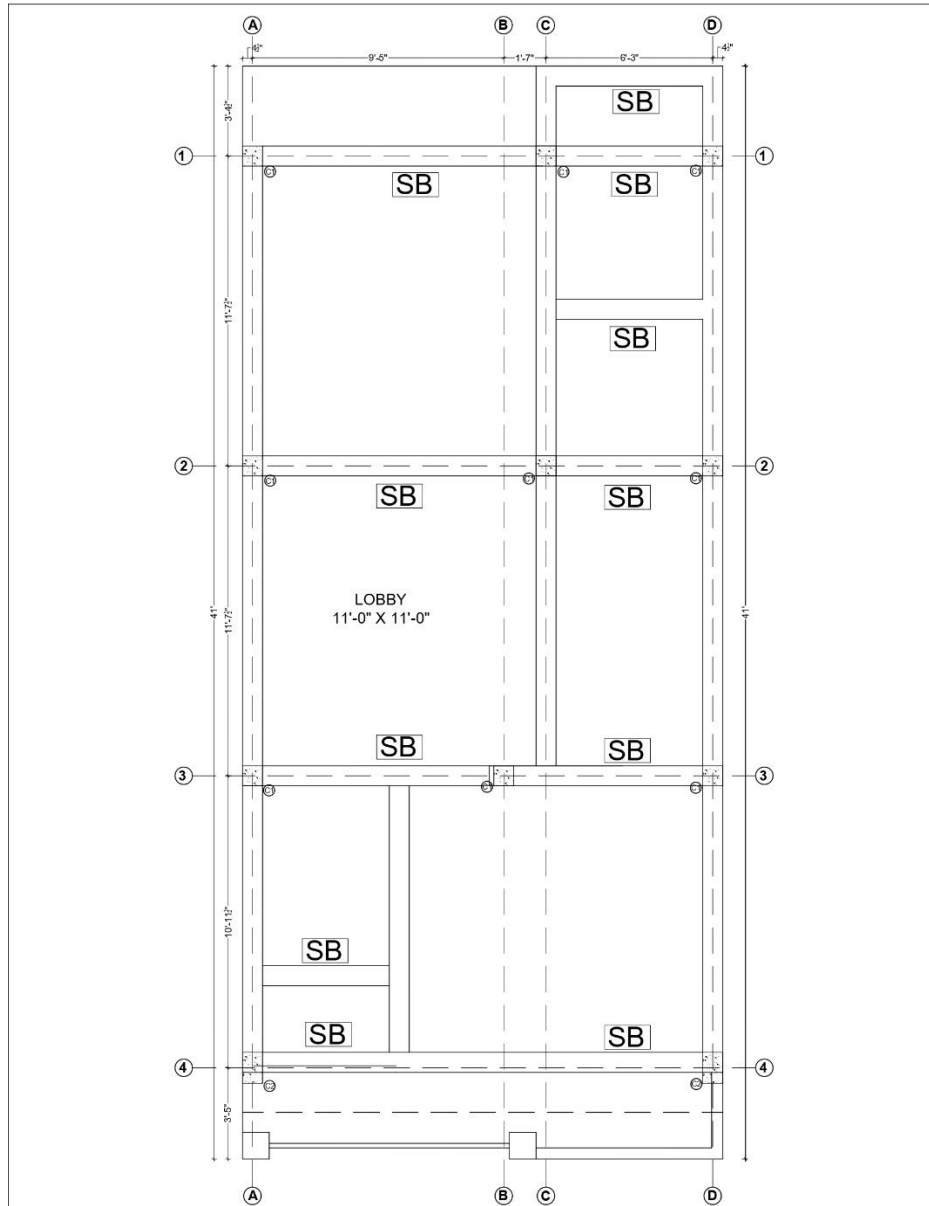

REFERENCE IMAGE



	DELUSION INTERIO PVT. LTD., GMS ROAD, DEHRADUN			
	CLIENT NAME: Mr.Rajat Ahuja	PROJECT: Proposed Residence	PROPORTION: NOT TO SCALE	

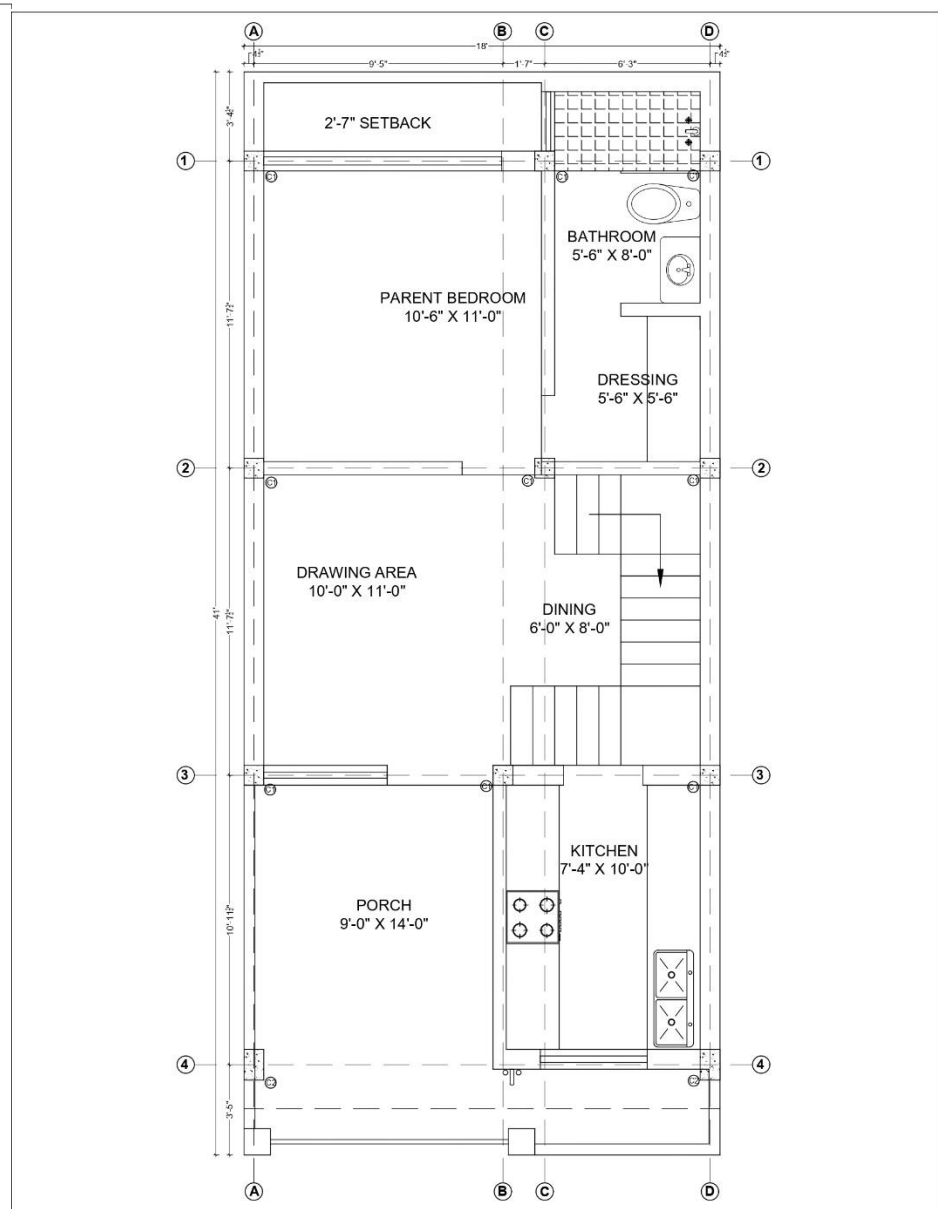
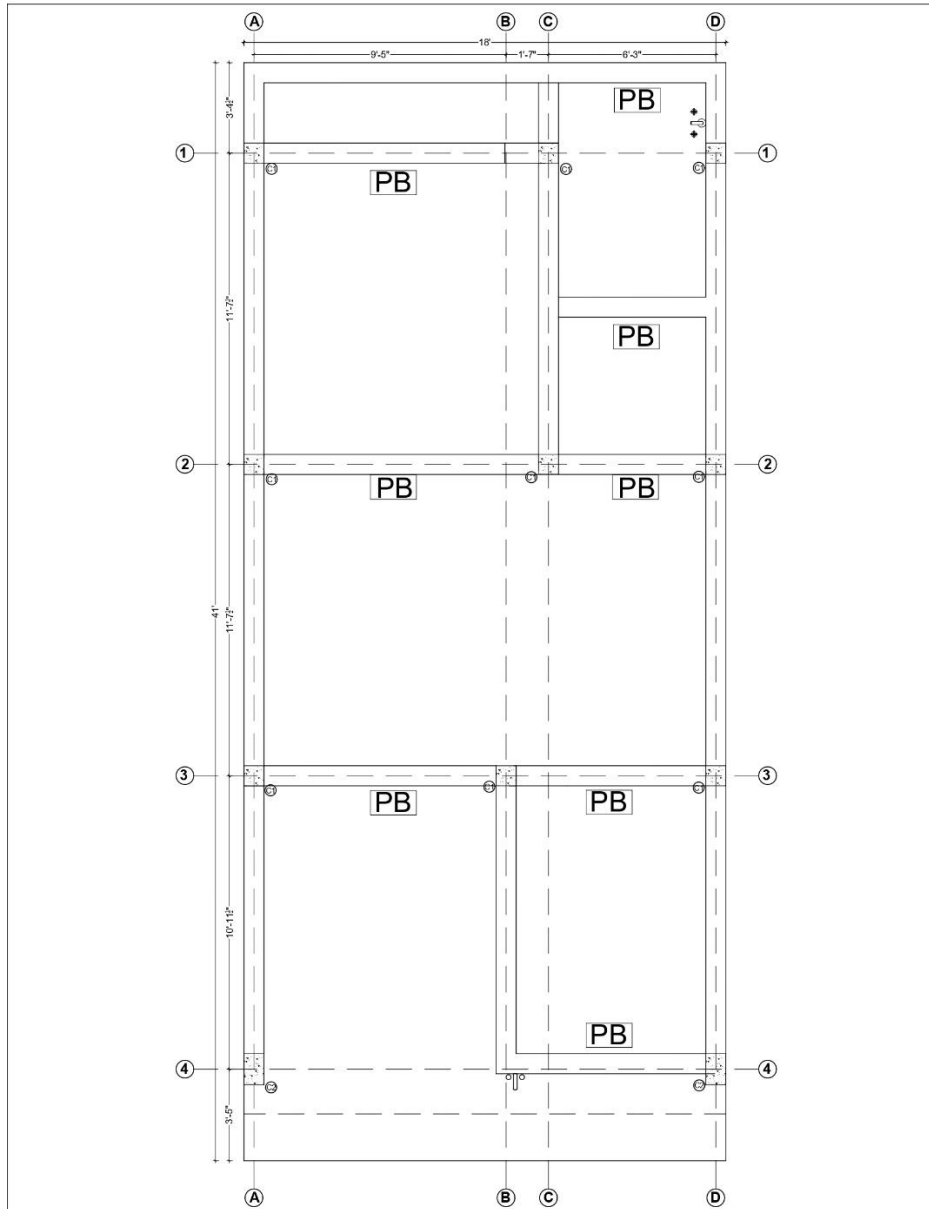

 DELUSION INTERIO <small>DESIGN DECOR DETAIL</small>	DELUSION INTERIO PVT. LTD., GMS ROAD, DEHRADUN				
	CLIENT NAME: Mr. Rajat Ahuja	PROJECT: Proposed Residence	PROPORTION: NOT TO SCALE	DRAWING: GROUND FLOOR SLAB BEAM PLAN	



 DELUSION INTERIO <small>DESIGN & CONSTRUCTION</small>	DELUSION INTERIO PVT. LTD., GMS ROAD, DEHRADUN				
	CLIENT NAME: Mr.Rajat Ahuja	PROJECT: Proposed Residence	PROPORTION: NOT TO SCALE	DRAWING: GROUND FLOOR PLINTH BEAM PLAN	

 DELUSION INTERIO <small>DESIGN & CONSTRUCTION</small>	DELUSION INTERIO PVT. LTD., GMS ROAD, DEHRADUN				
	CLIENT NAME: Mr.Rajat Ahuja	PROJECT: Proposed Residence	PROPORTION: NOT TO SCALE	DRAWING: GROUND FLOOR CENTER LINE PLAN	

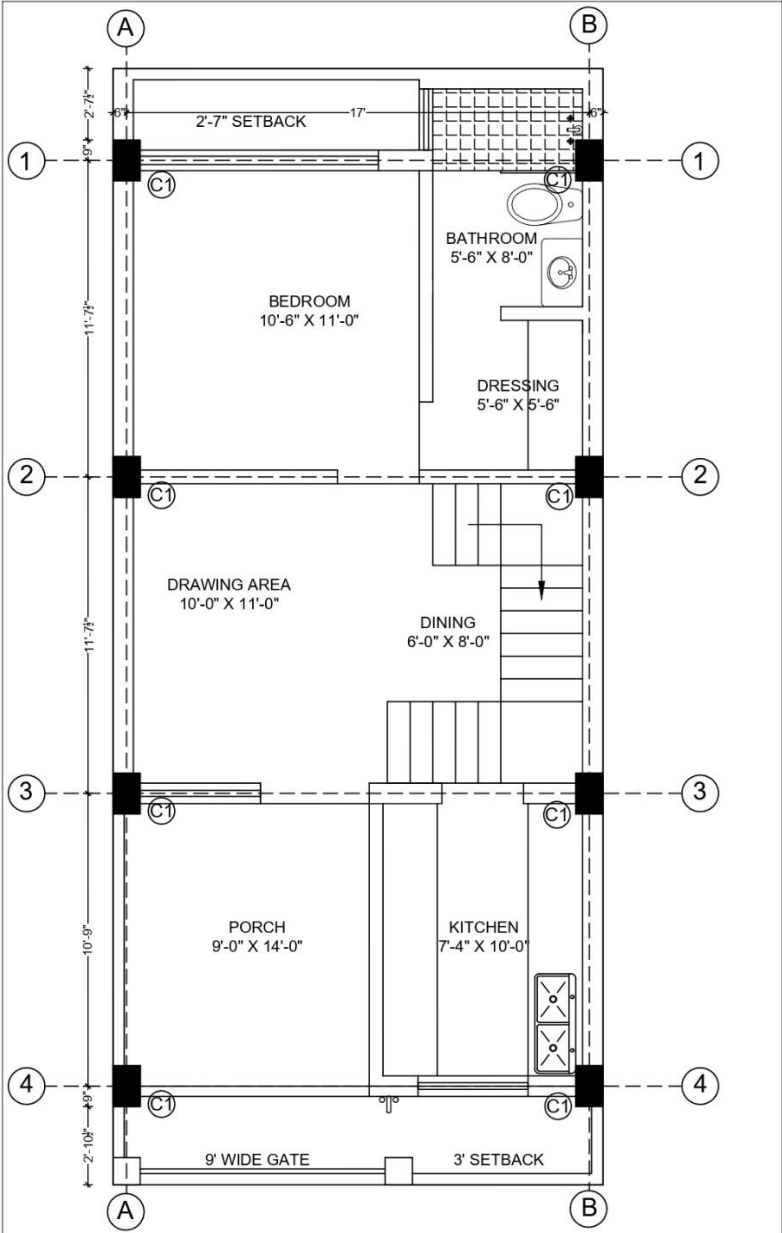

..A.M1.jpg	DELUSION INTERIO PVT. LTD., GMS ROAD, DEHRADUN			
	CLIENT NAME: Mr. Rajat Ahuja	PROJECT: Proposed Residence	PROPORTION: NOT TO SCALE	

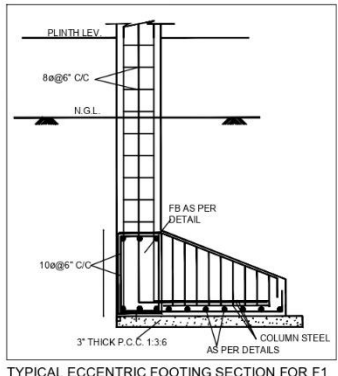
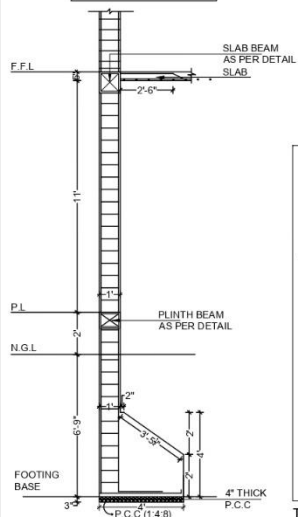
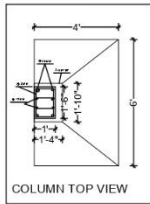

C1	FOUNDATION TO TOP LEVEL	SIZE 12" X 18"	
		STEEL	4Nos. 20mmØ
		RING	4Nos. 12mm Ø
PB	PLINTH BEAM	SIZE 12" X 9"	
		STEEL	4Nos. 16mmØ
		RING	8Ø@100 C/C 6" SPACING
SB	SLAB BEAM	SIZE 12" X 12"	
		STEEL	4Nos. 16mmØ
		RING	8Ø@100 C/C 6" SPACING

..11.jpg

DELUSION INTERIO PVT. LTD., GMS ROAD, DEHRADUN

CLIENT NAME:
Mr. Rajat Ahuja

PROJECT:
Proposed Residence

PROPORTION:
NOT TO SCALE

DETAIL DRAWING

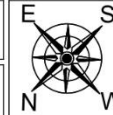

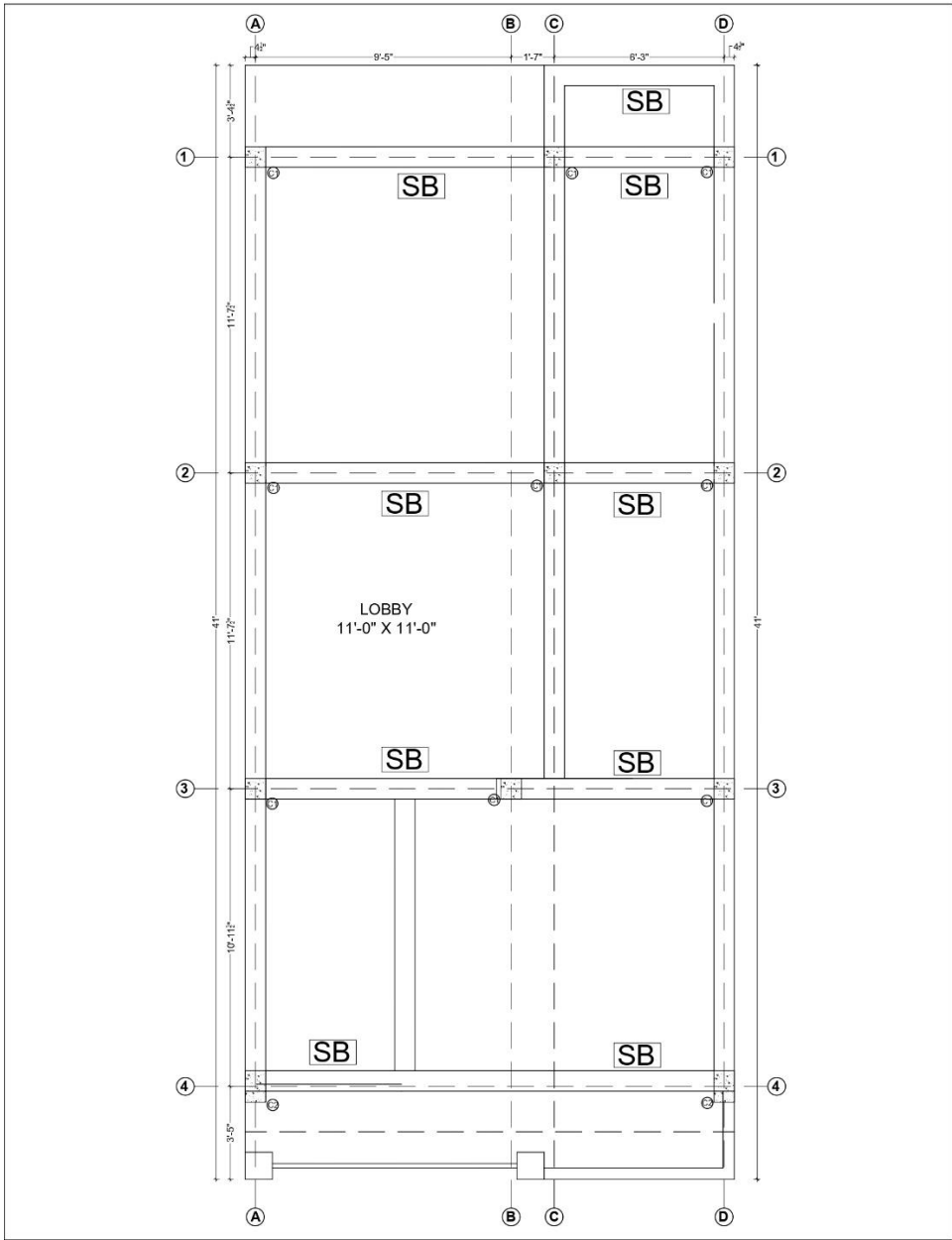



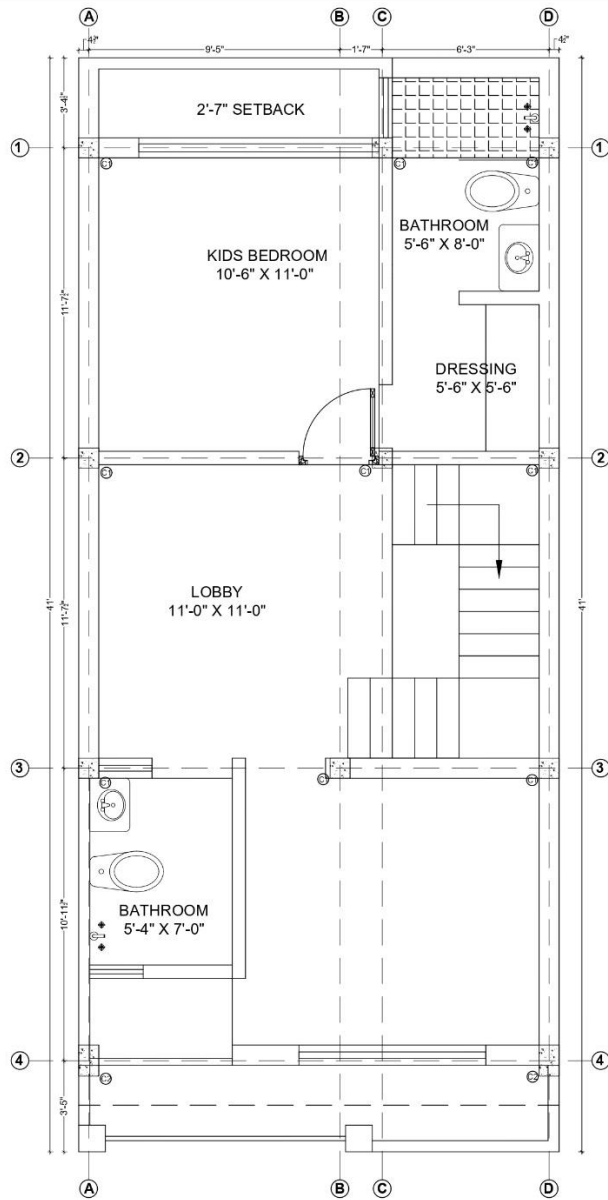

DELUSION INTERIO PVT. LTD., GMS ROAD, DEHRADUN
 CLIENT NAME: Mr. Rajat Ahuja
 PROJECT: Proposed Residence
 PROPORTION: NOT TO SCALE
 DRAWING: FIRST FLOOR SLAB BEAM PLAN



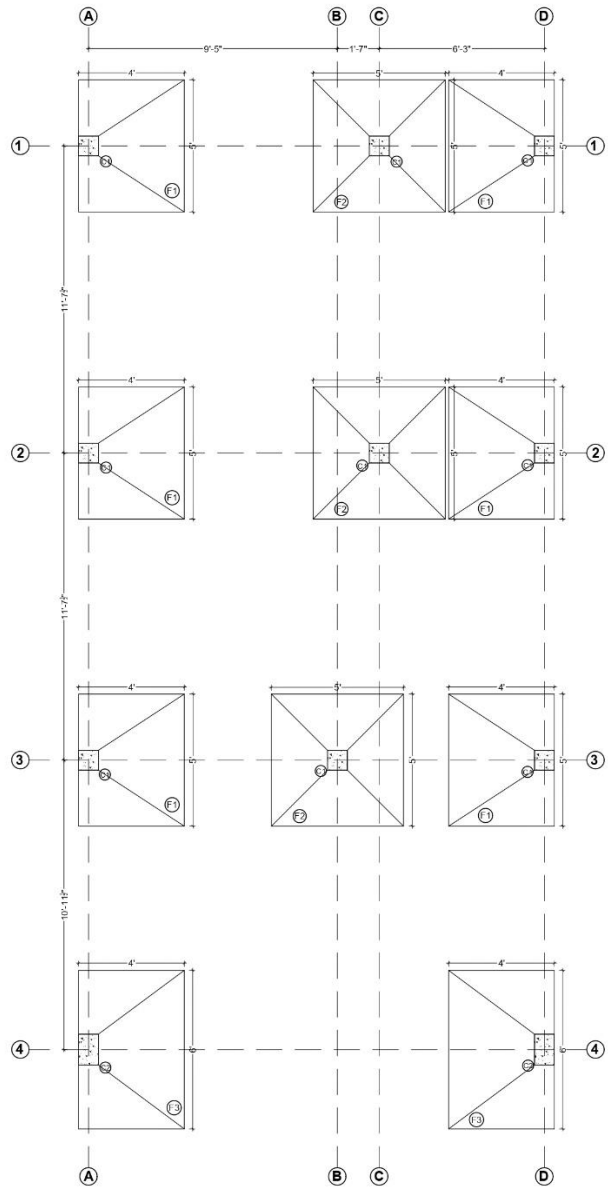

 DELUSION INTERIO <small>DESIGN DECOR STYLE</small>	DELUSION INTERIO PVT. LTD., GMS ROAD, DEHRADUN			
	CLIENT NAME: Mr. Rajat Ahuja	PROJECT: Proposed Residence	PROPORTION: NOT TO SCALE	



 DELUSION INTERIO <small>DESIGN • CONCEPT • EXECUTION</small>	DELUSION INTERIO PVT. LTD., GMS ROAD, DEHRADUN			
	CLIENT NAME: Mr. Rajat Ahuja	PROJECT: Proposed Residence	PROPORTION: NOT TO SCALE	

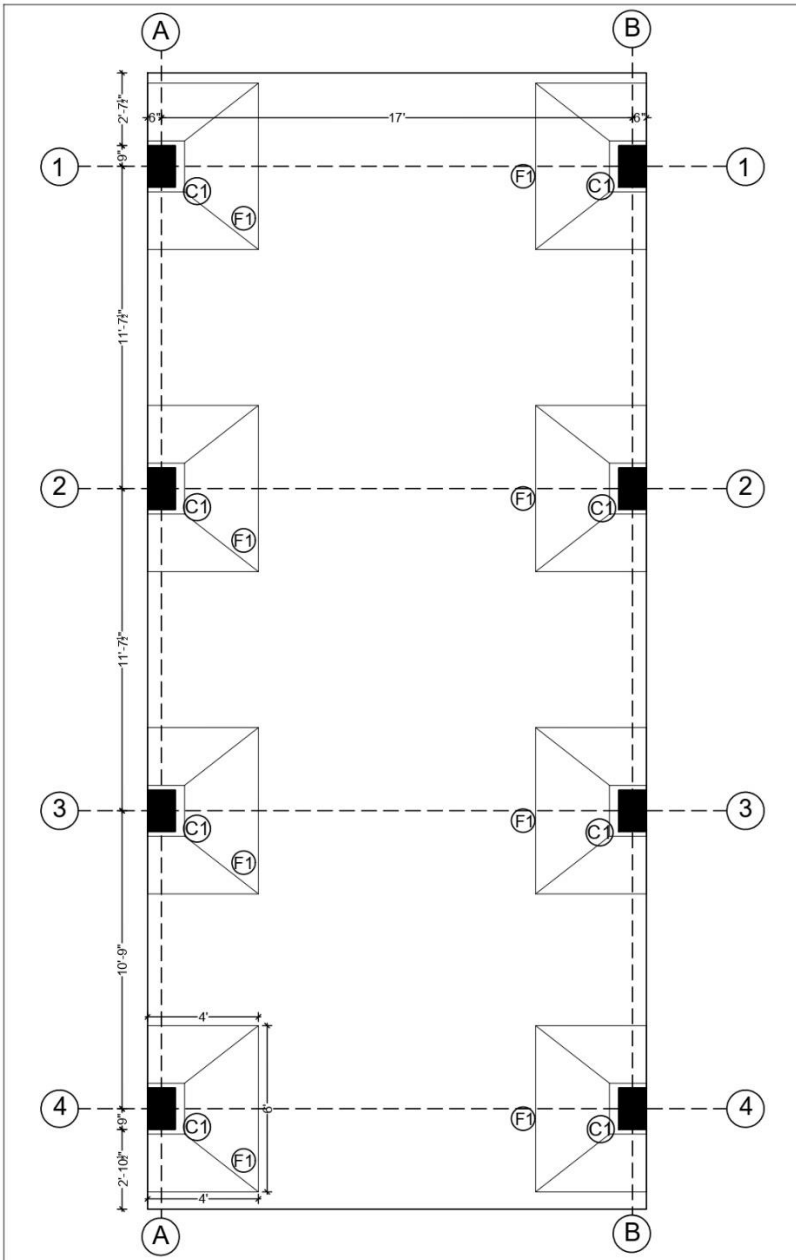

..A..1.jpg	DELUSION INTERIO PVT. LTD., GMS ROAD, DEHRADUN			
	CLIENT NAME: Mr. Rajat Ahuja	PROJECT: Proposed Residence	PROPORTION: NOT TO SCALE	

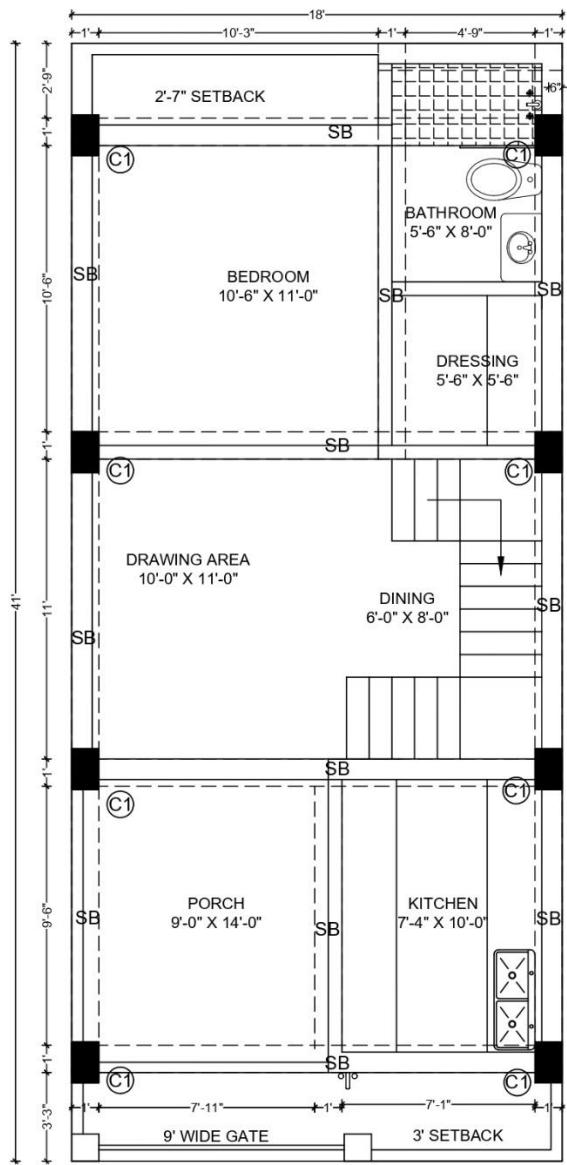

..A.11.jpg

DELUSION INTERIO PVT. LTD., GMS ROAD, DEHRADUN

CLIENT NAME:
Mr. Rajat Ahuja

PROJECT:
Proposed Residence

PROPORTION:
NOT TO SCALE

DRAWING:
SLAB BEAM PLAN



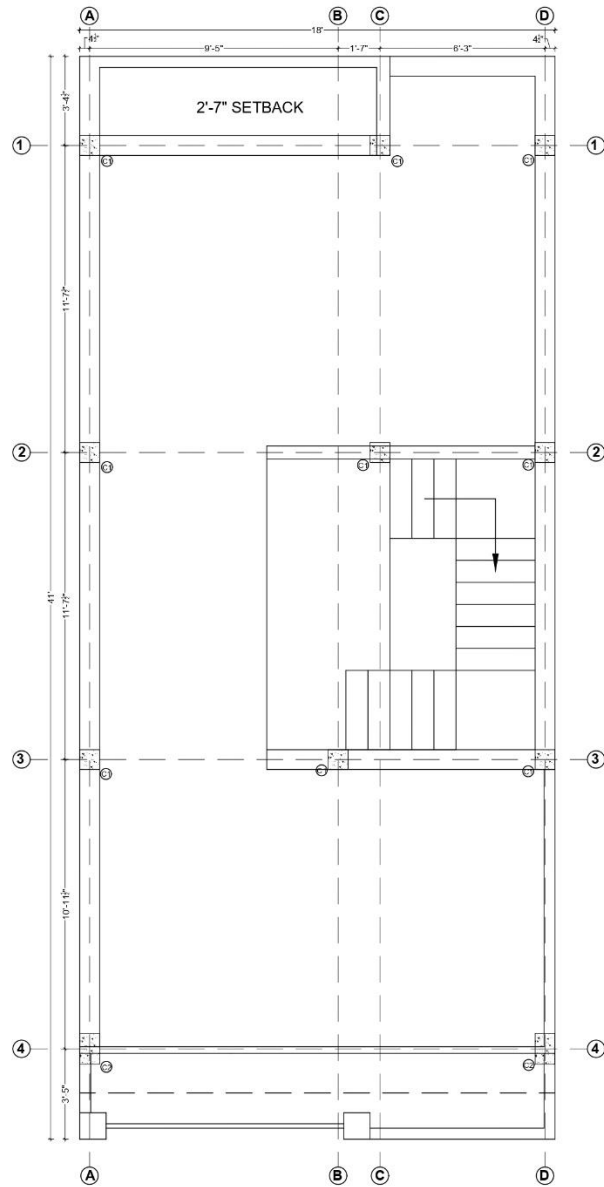

DELUSION INTERIO PVT. LTD., GMS ROAD, DEHRADUN

CLIENT NAME:
Mr.Rajat Ahuja

PROJECT:
Proposed Residence

PROPORTION:
NOT TO SCALE

DRAWING:
TERRACE CENTER LINE PLAN



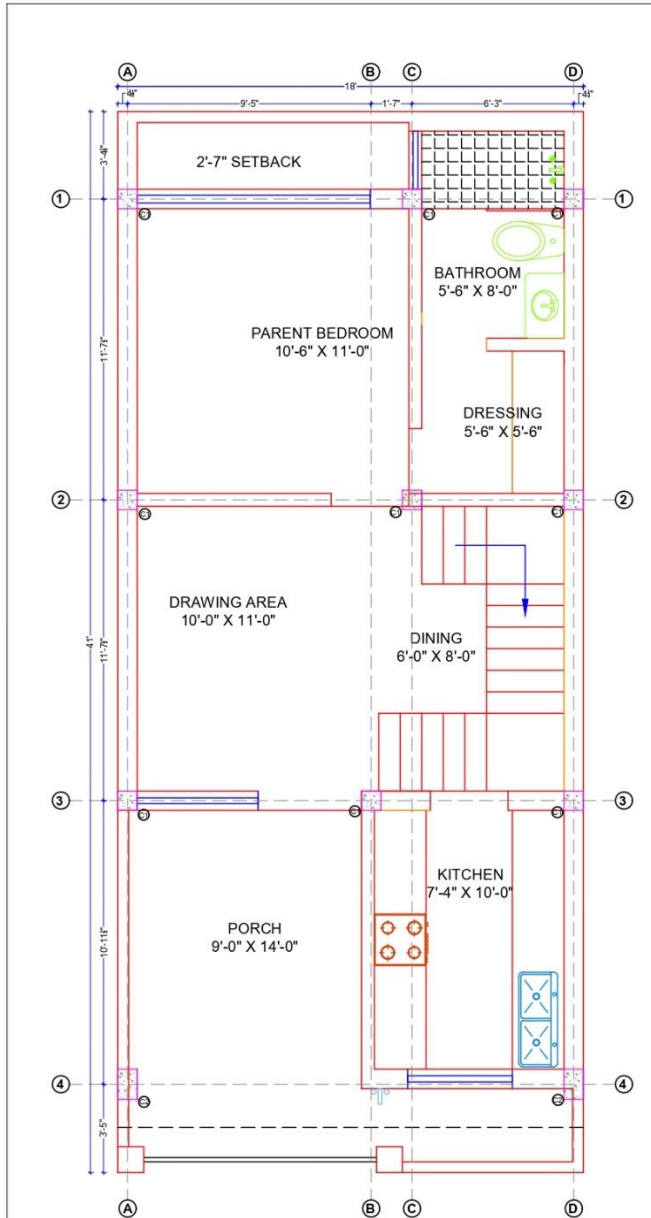

	DELUSION INTERIO PVT. LTD., GMS ROAD, DEHRADUN			
	CLIENT NAME: Mr. Rajat Ahuja	PROJECT: Proposed Residence	PROPORTION: NOT TO SCALE	

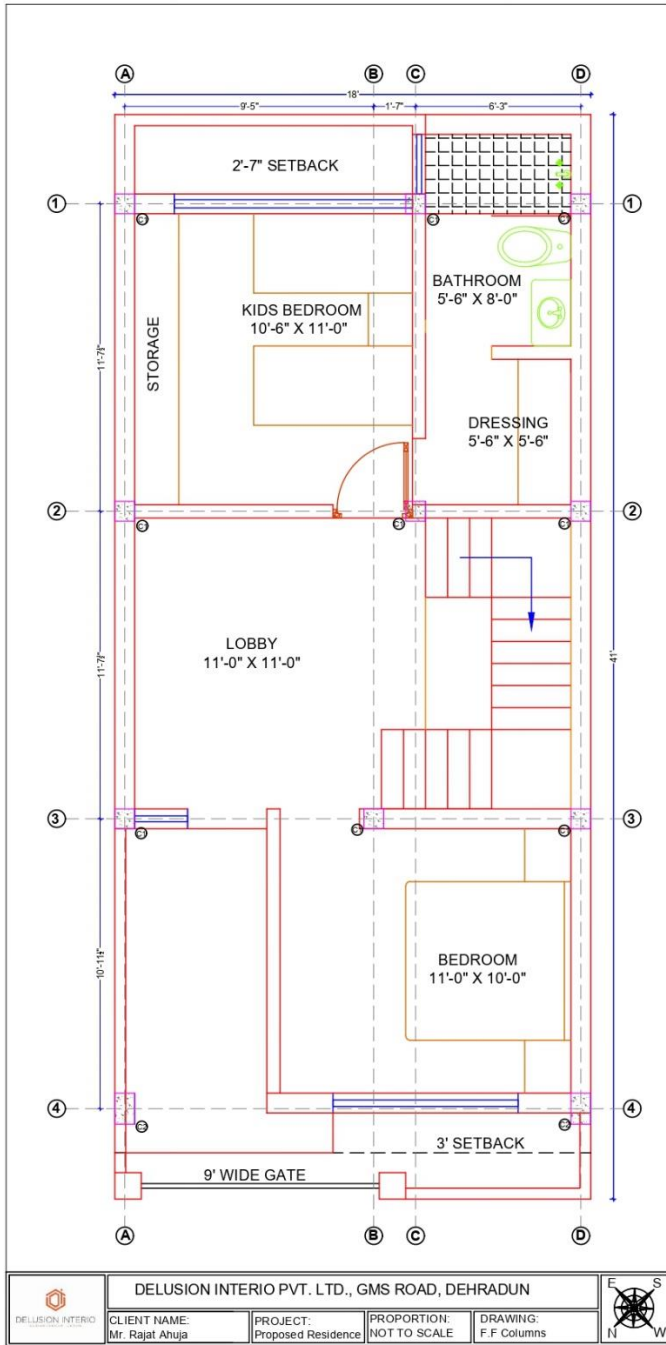

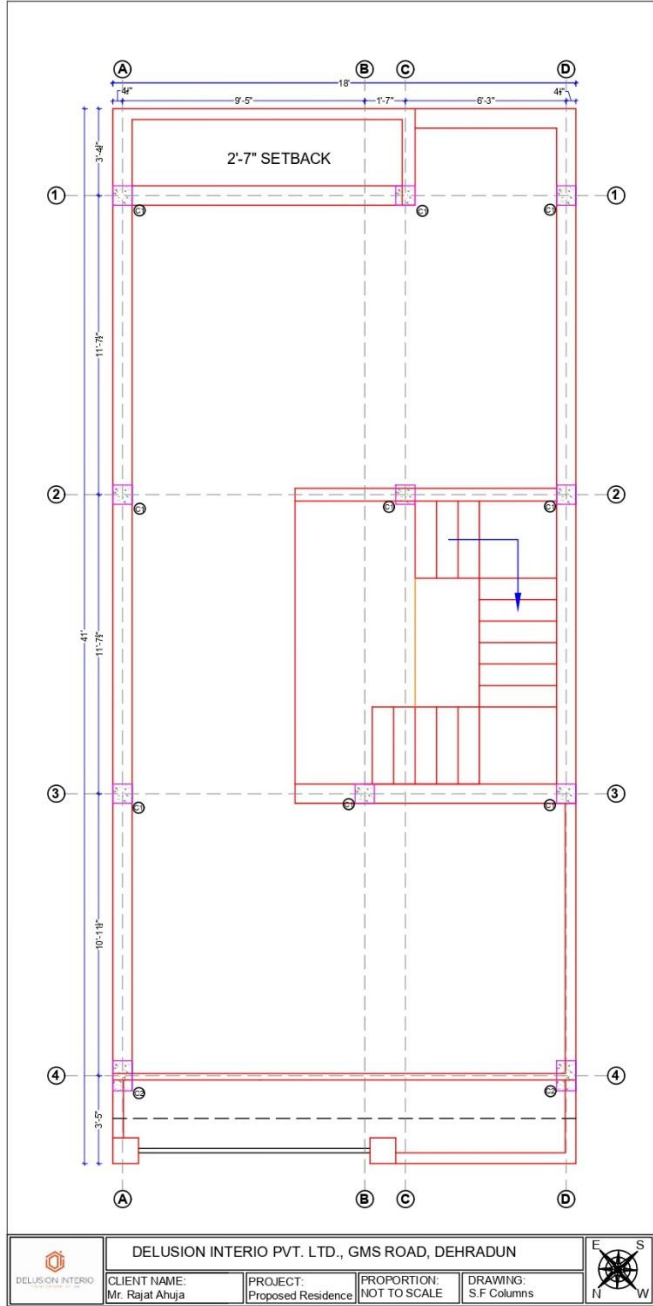

 DELUSION INTERIO	DELUSION INTERIO PVT. LTD., GMS ROAD, DEHRADUN			
	CLIENT NAME: Mr. Rajat Anuja	PROJECT: Proposed Residence	PROPORTION: NOT TO SCALE	



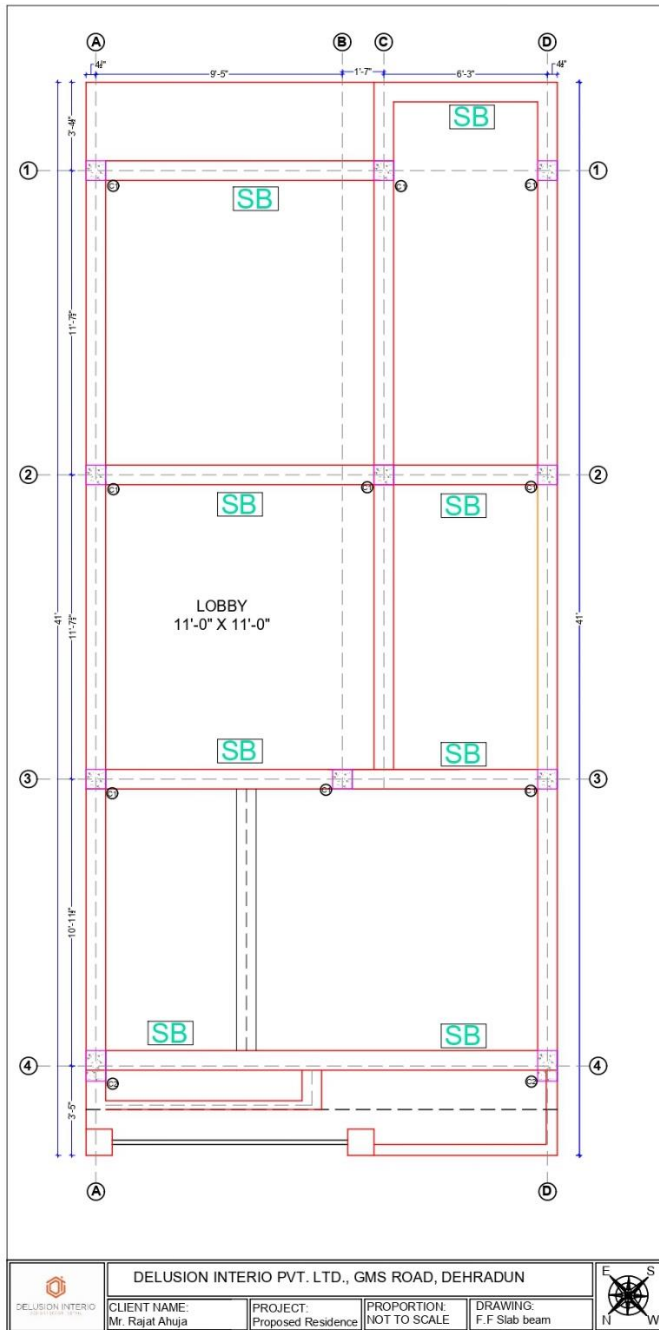

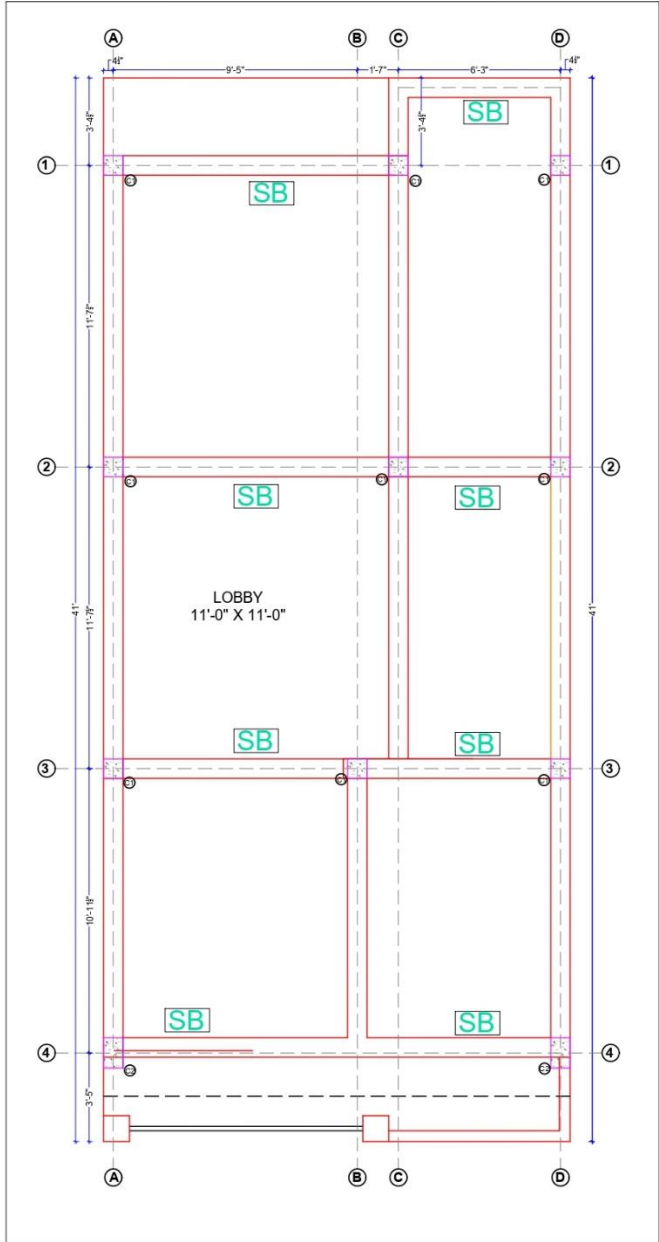
 DELUSION INTERIO	DELUSION INTERIO PVT. LTD., GMS ROAD, DEHRADUN			
	CLIENT NAME: Mr. Rajat Ahuja	PROJECT: Proposed Residence	PROPORTION: NOT TO SCALE	



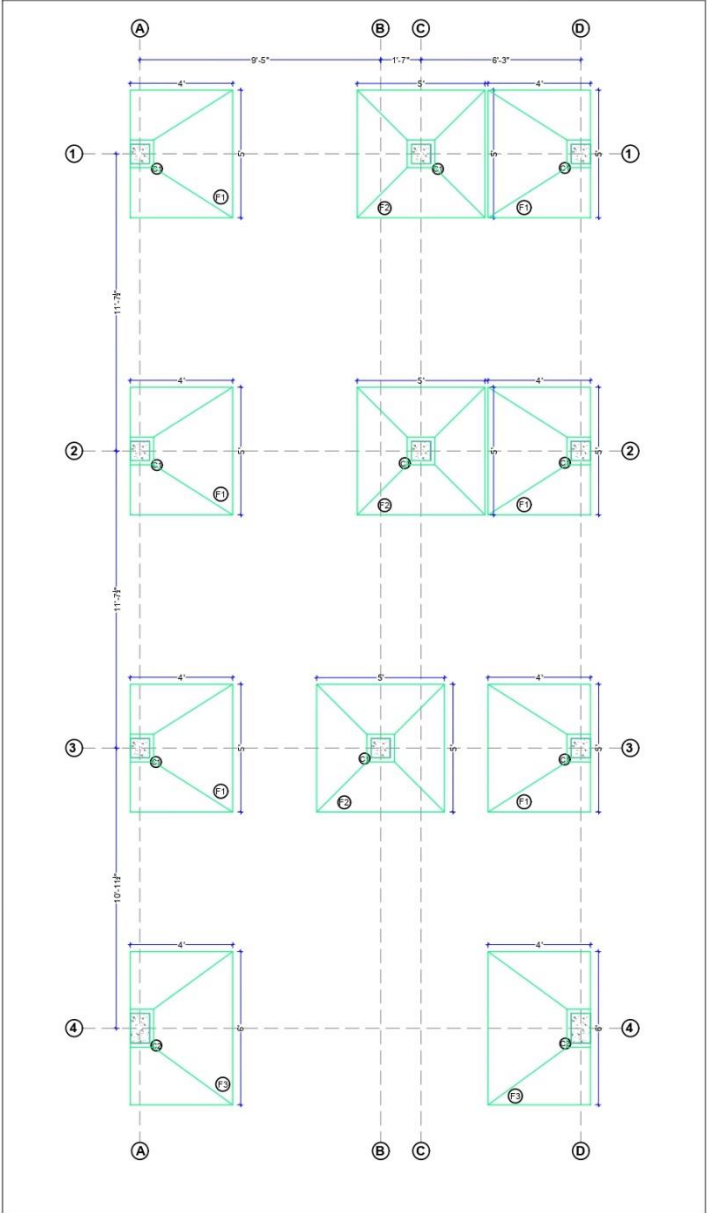

	DELUSION INTERIO PVT. LTD., GMS ROAD, DEHRADUN			
	CLIENT NAME: Mr. Rajat Ahuja	PROJECT: Proposed Residence	PROPORTION: NOT TO SCALE	



	DELUSION INTERIO PVT. LTD., GMS ROAD, DEHRADUN			
	CLIENT NAME: Mr. Rajat Ahuja	PROJECT: Proposed Residence	PROPORTION: NOT TO SCALE	

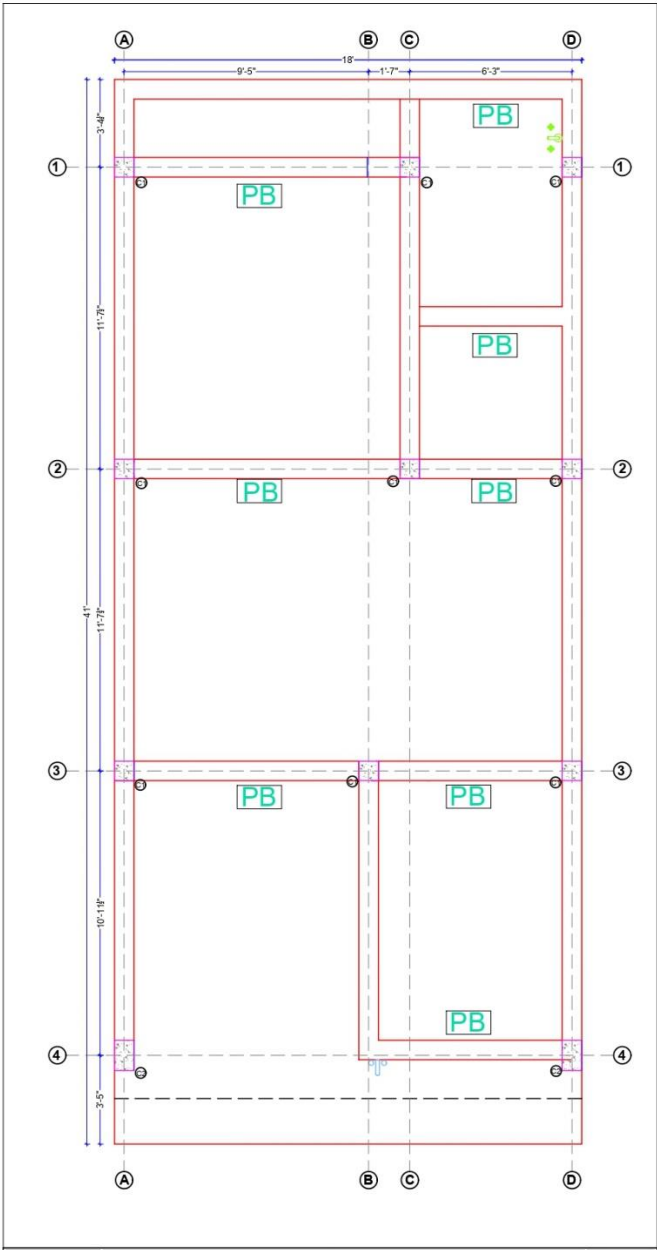

 DELUSION INTERIO	GROUND FLOOR DELUSION INTERIO ROAD, DEHRADUN			 N S E W
	CLIENT NAME: Mr. Rajat Ahuja	PROJECT: Proposed Residence	PROPORTION: NOT TO SCALE	

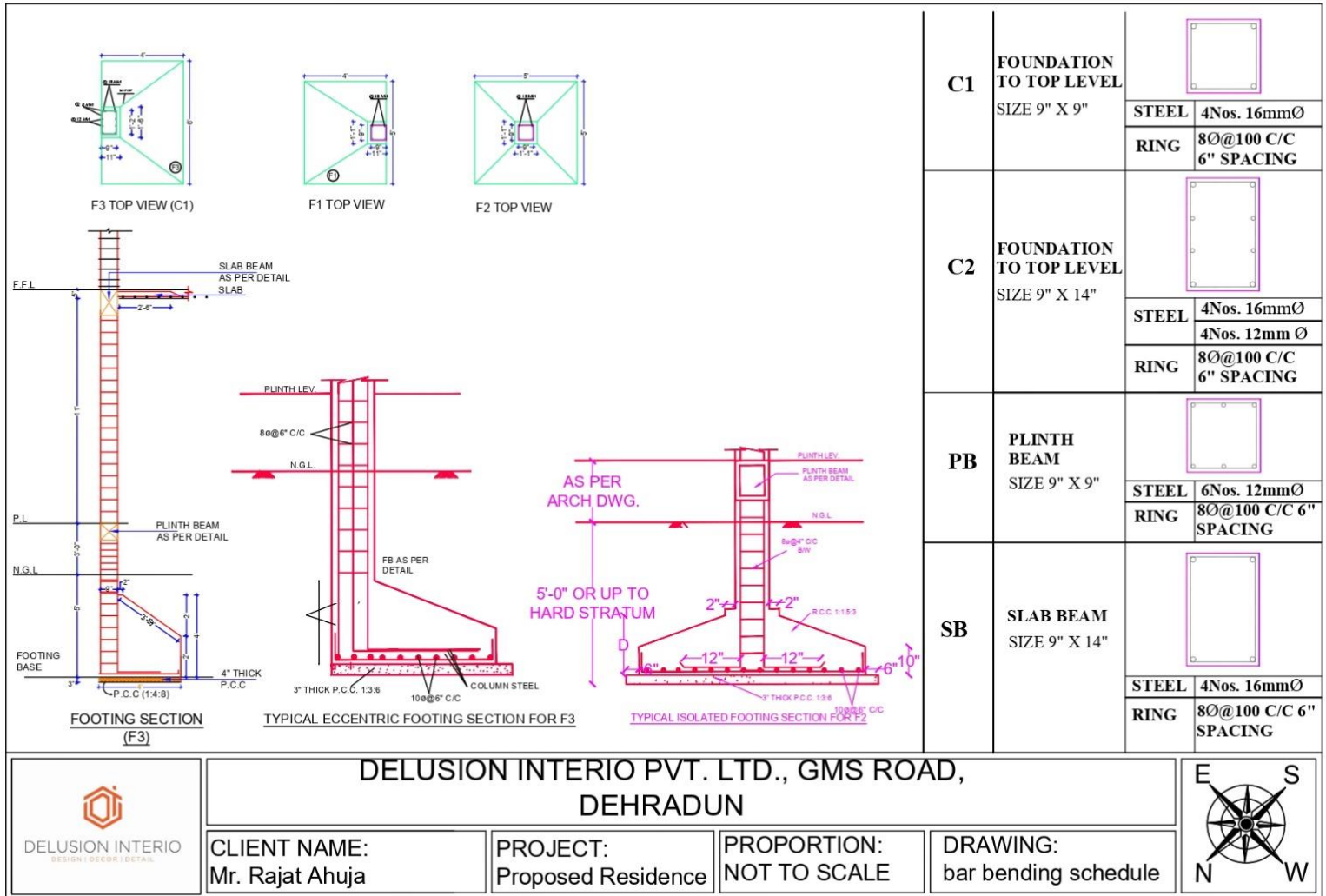

DELUSION INTERIO PVT. LTD., GMS ROAD, DEHRADUN



CLIENT NAME:
Mr. Rajat Ahuja

PROJECT:
Proposed Residence

PROPORTION:
NOT TO SCALE

DRAWING:
bar bending schedule



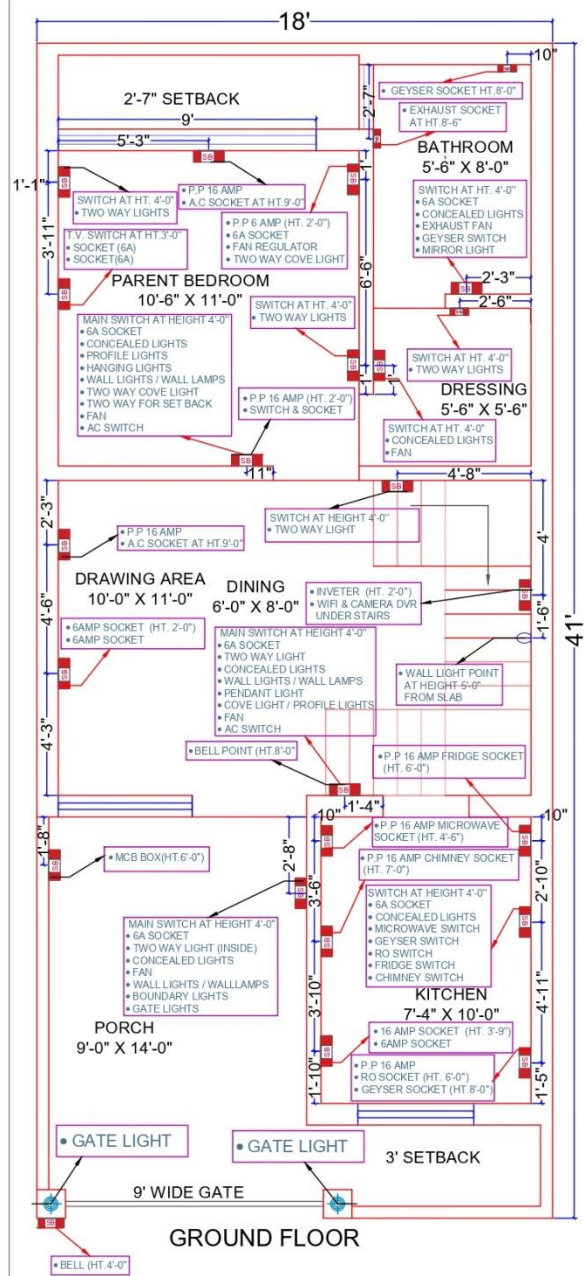



 DELUSION INTERIO	DELUSION INTERIO PVT. LTD., GMS ROAD, DEHRADUN			
	CLIENT NAME Mr. Rajat Ahuja	PROJECT Proposed Residence	PROPORTION NOT TO SCALE	DRAWING Electrical Plan

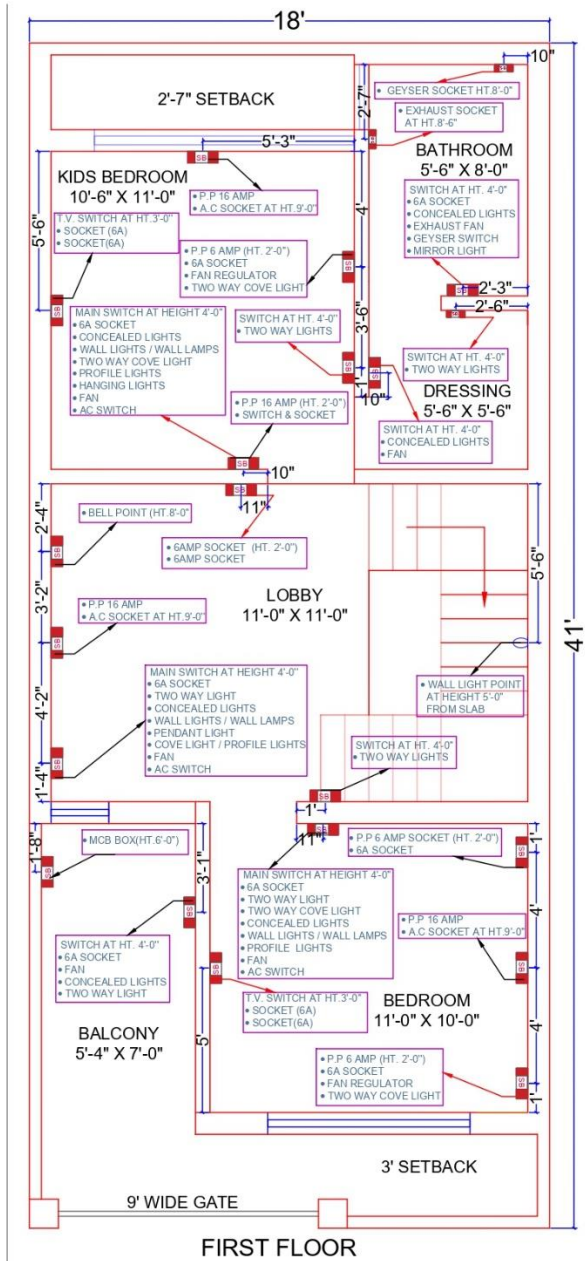

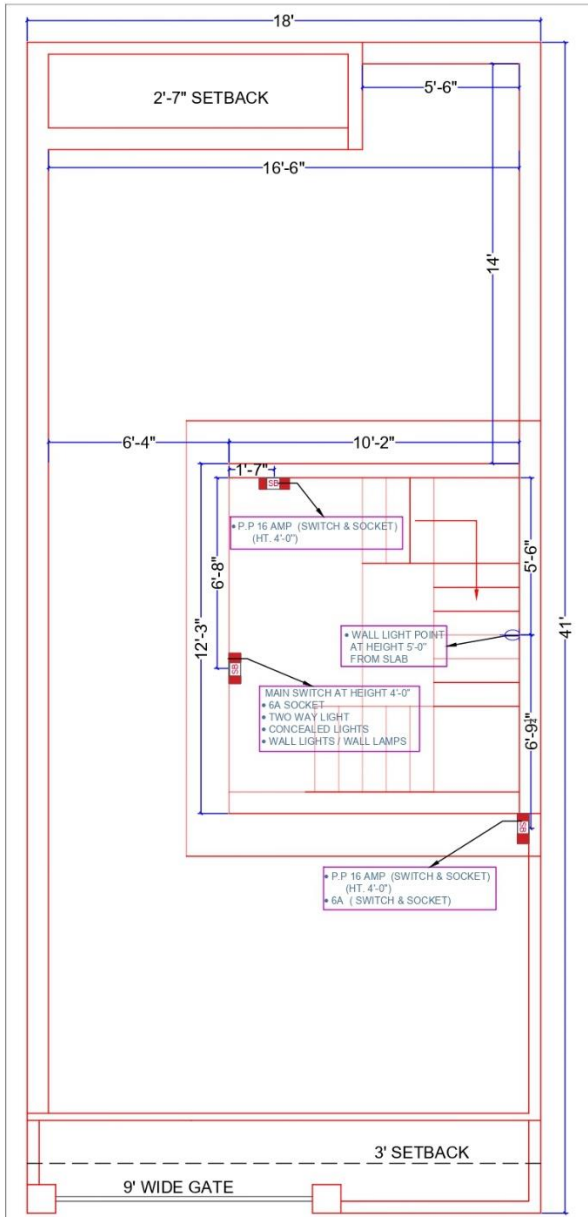



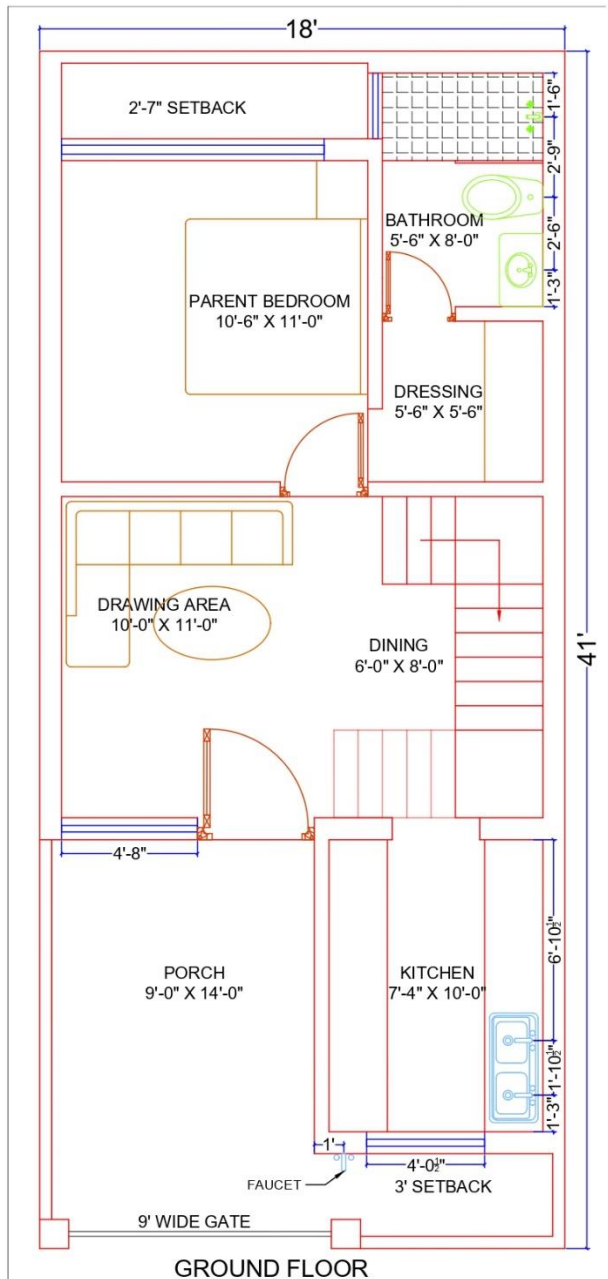

SECOND FLOOR

	DELUSION INTERIO PVT. LTD., GMS ROAD, DEHRADUN			
	CLIENT NAME Mr. Rajat Ahuja	PROJECT: Proposed Residence	PROPORTION: NOT TO SCALE	



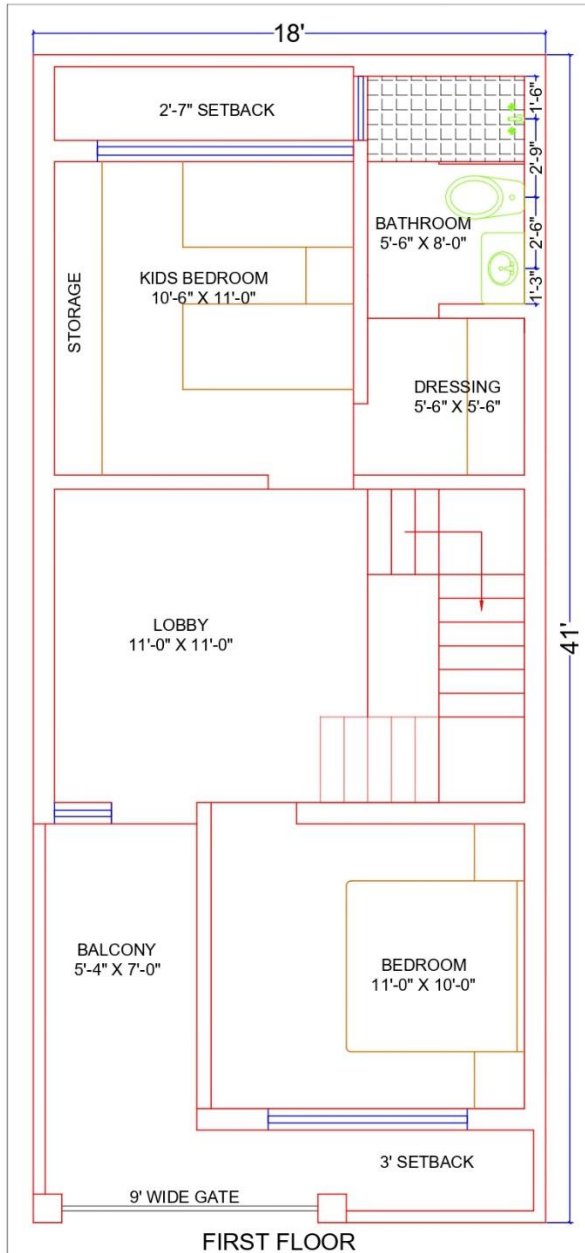

	DELUSION INTERIO PVT. LTD., GMS ROAD, DEHRADUN				
	CLIENT NAME: Mr. Rajat Ahuja	PROJECT: Proposed Residence	PROPORTION: NOT TO SCALE	DRAWING: Plumbing Plan	

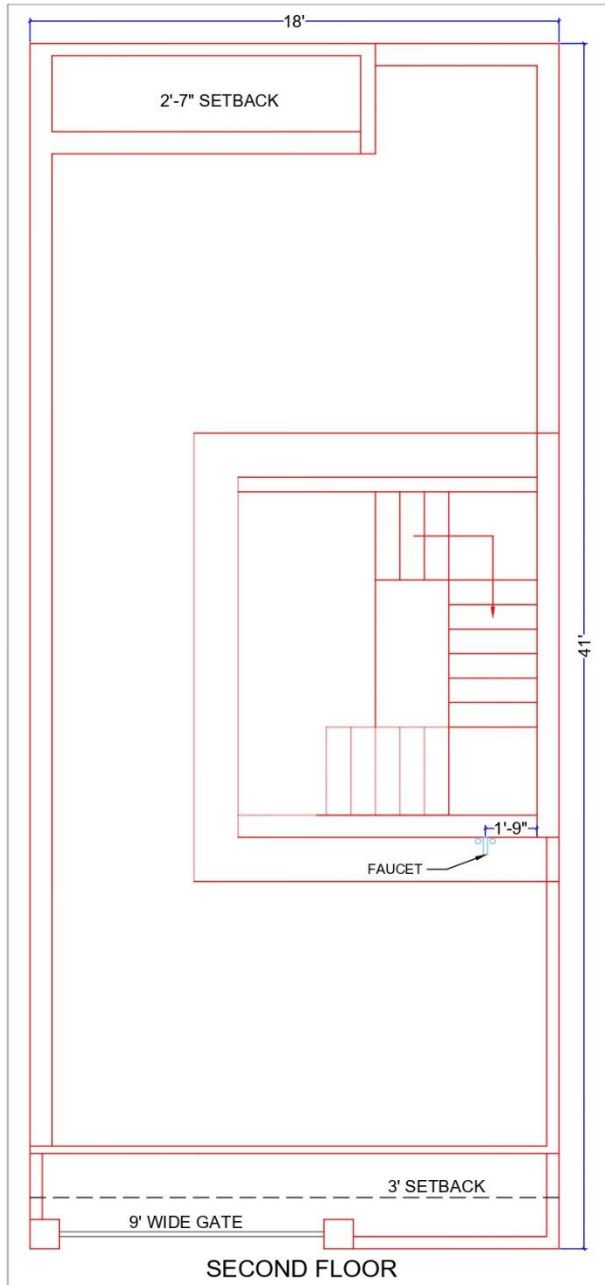

 DELUSION INTERIO <small>INTERIOR DESIGN & CONSTRUCTION</small>	DELUSION INTERIO PVT. LTD., GMS ROAD, DEHRADUN				 E S N W
	CLIENT NAME: Mr. Rajat Ahuja	PROJECT: Proposed Residence	PROPORTION: NOT TO SCALE	DRAWING: Plumbing Plan	



 DELUSION INTERIO	DELUSION INTERIO PVT. LTD., GMS ROAD, DEHRADUN				
	CLIENT NAME: Mr. Rajat Ahuja	PROJECT: Proposed Residence	PROPORTION: NOT TO SCALE	DRAWING: Plumbing Plan	

DOOR & Window Schedule

	W	V	DW	W ₁	W ₂	W ₃	GLAZING	D	D ₁
WINDOW VENTILATION NAME									
PLAN WINDOW VENTILATION									
SHAPE / SIZE									
	• Total No. of Window - 1pc	• Total No. of Ventilations - 2pc	• Total No. of Window - 1pc • Total No. of Door - 1pc	• Total No. of Window - 1pc	• Total No. of Window - 2pc	• Total No. of Window - 1pc	• Total No. of GLAZING - 1pc	• Total No. of Doors - 4pc	• Total No. of Doors - 2pc
SPECIFICATION	• Total No. of Window - 0pc • Total No. of Ventilations - 2pc	• Ventilations - (2pc) • Both Bathroom - 2x2	• WOODEN WINDOW • OPENABLE SHUTTER • DOOR	• UPVC SLIDING WINDOW • 3 Track Mechanism • 5mm Toughened Glass • Mosquito Mesh	• UPVC SLIDING WINDOW • 3 Track Mechanism • 5mm Toughened Glass • Mosquito Mesh	• UPVC SLIDING WINDOW • 3 Track Mechanism • 5mm Toughened Glass • Mosquito Mesh			



DELUSION INTERIO
DESIGN | DECOR | DETAIL

DELUSION INTERIO PVT. LTD., GMS ROAD, DEHRADUN

CLIENT NAME:
Mr. Rajat Ahuja

PROJECT:
Proposed Residence

PROPORTION:
NOT TO SCALE

DRAWING:
DOOR AND Window Schedule

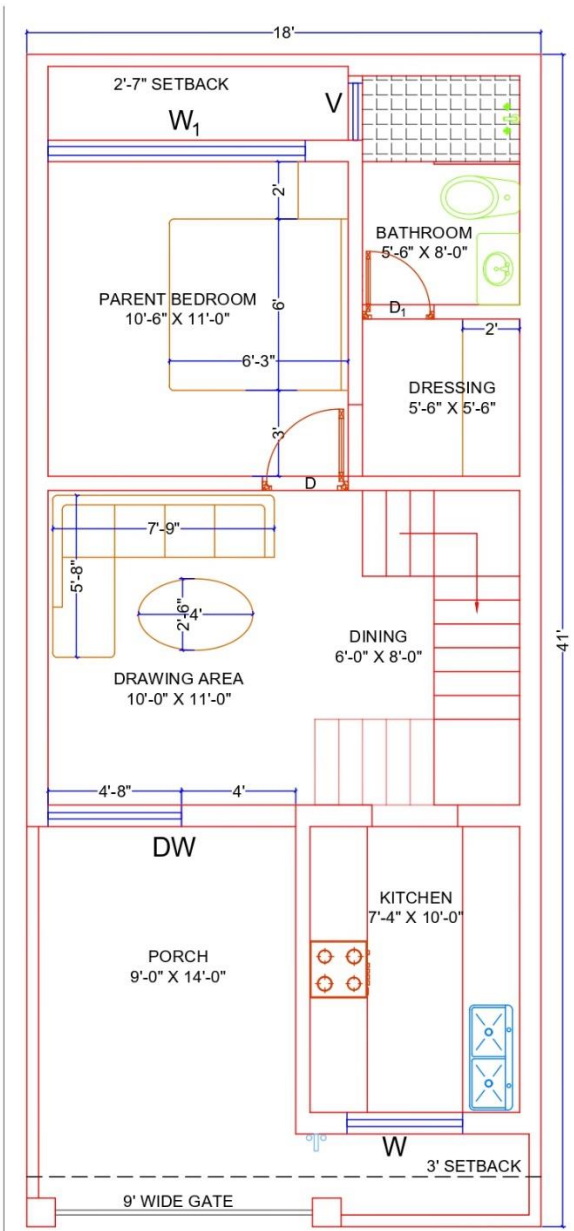

GROUND FLOOR

COVERED AREA :- 738sq.ft
CARPET AREA :- 563.29sq.ft

	DELUSION INTERIO PVT. LTD., GMS ROAD, DEHRADUN			
	CLIENT NAME: Mr. Rajat Ahuja	PROJECT: Proposed Residence	PROPORTION: NOT TO SCALE	



DELUSION INTERIO
DESIGN | DECOR | DETAIL



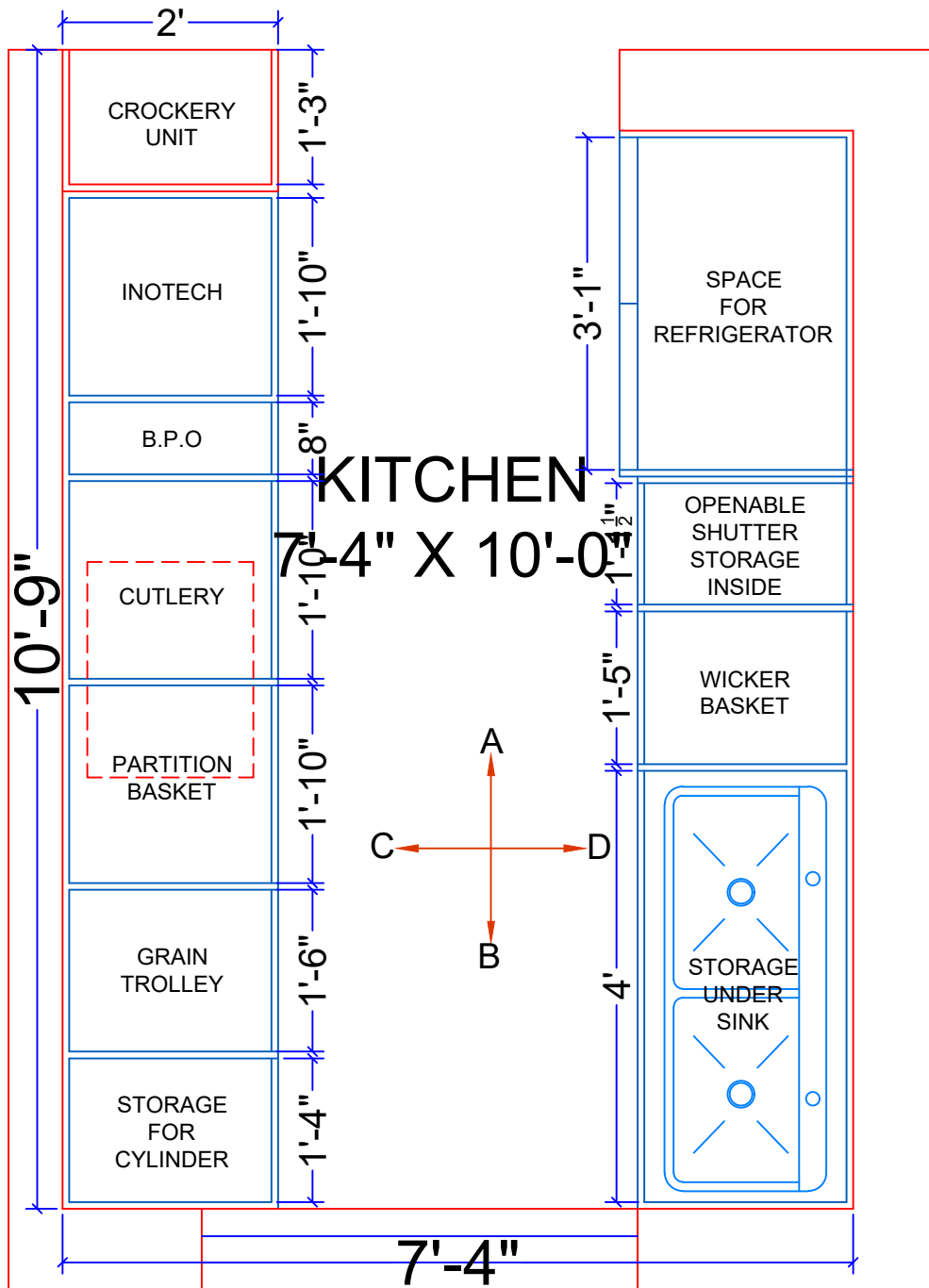

DELUSION INTERIO

DESIGN | DECOR | DETAIL



BELOW COUNTER PLAN

	DELUSION INTERIO PVT. LTD., GMS ROAD, DEHRADUN			
	CLIENT NAME: MR. RAJAT AHUJA	PROJECT: PROPOSED RESIDENCE	PROPORTION: NOT TO SCALE	

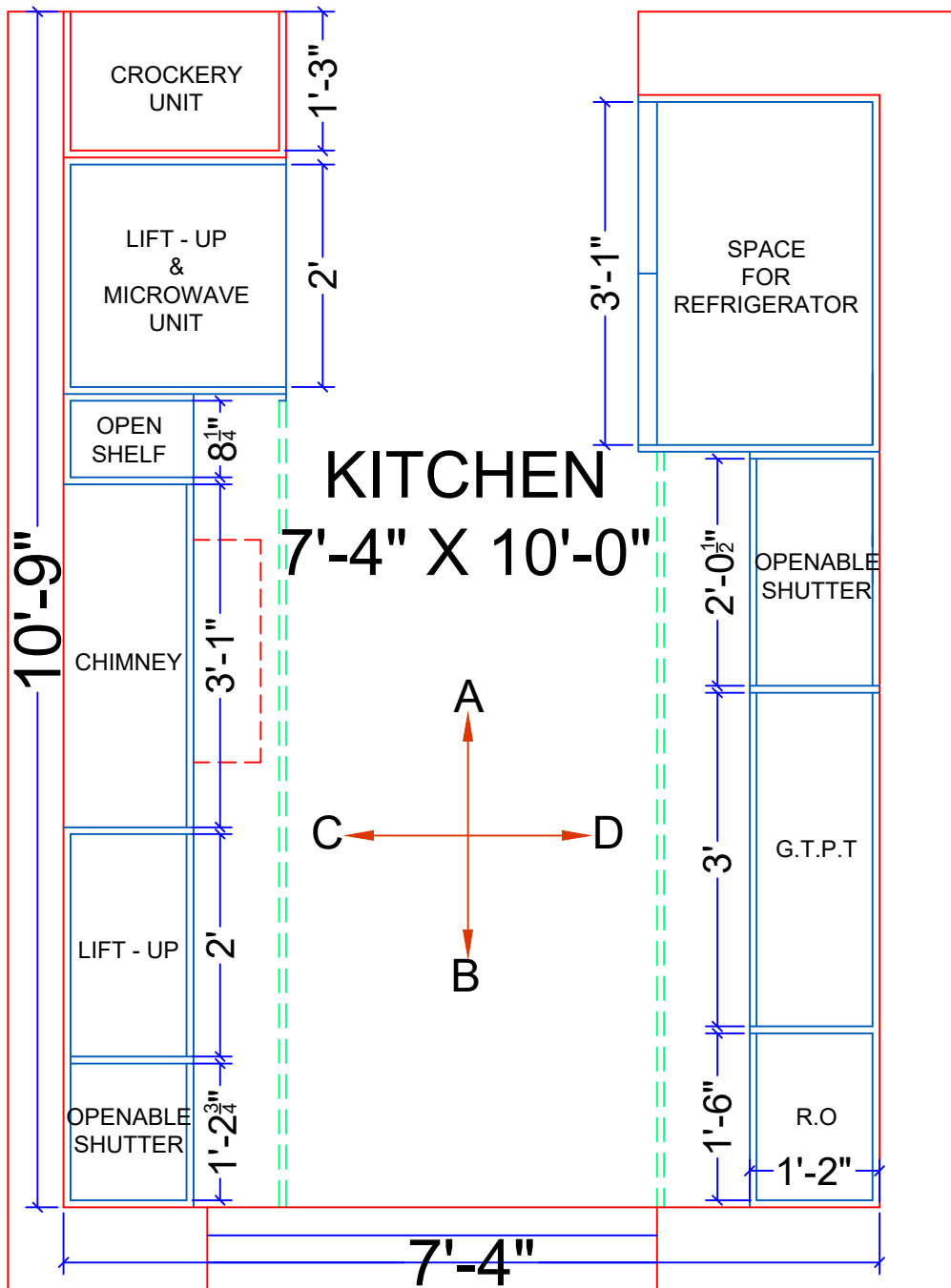

ABOVE COUNTER PLAN

NOTE : CONSIDER ONE CYLINDER STORAGE OUTSIDE TOO.

	DELUSION INTERIO PVT. LTD., GMS ROAD, DEHRADUN			
	CLIENT NAME: Mr. Rajat Ahuja	PROJECT: Proposed Residence	PROPORTION: NOT TO SCALE	

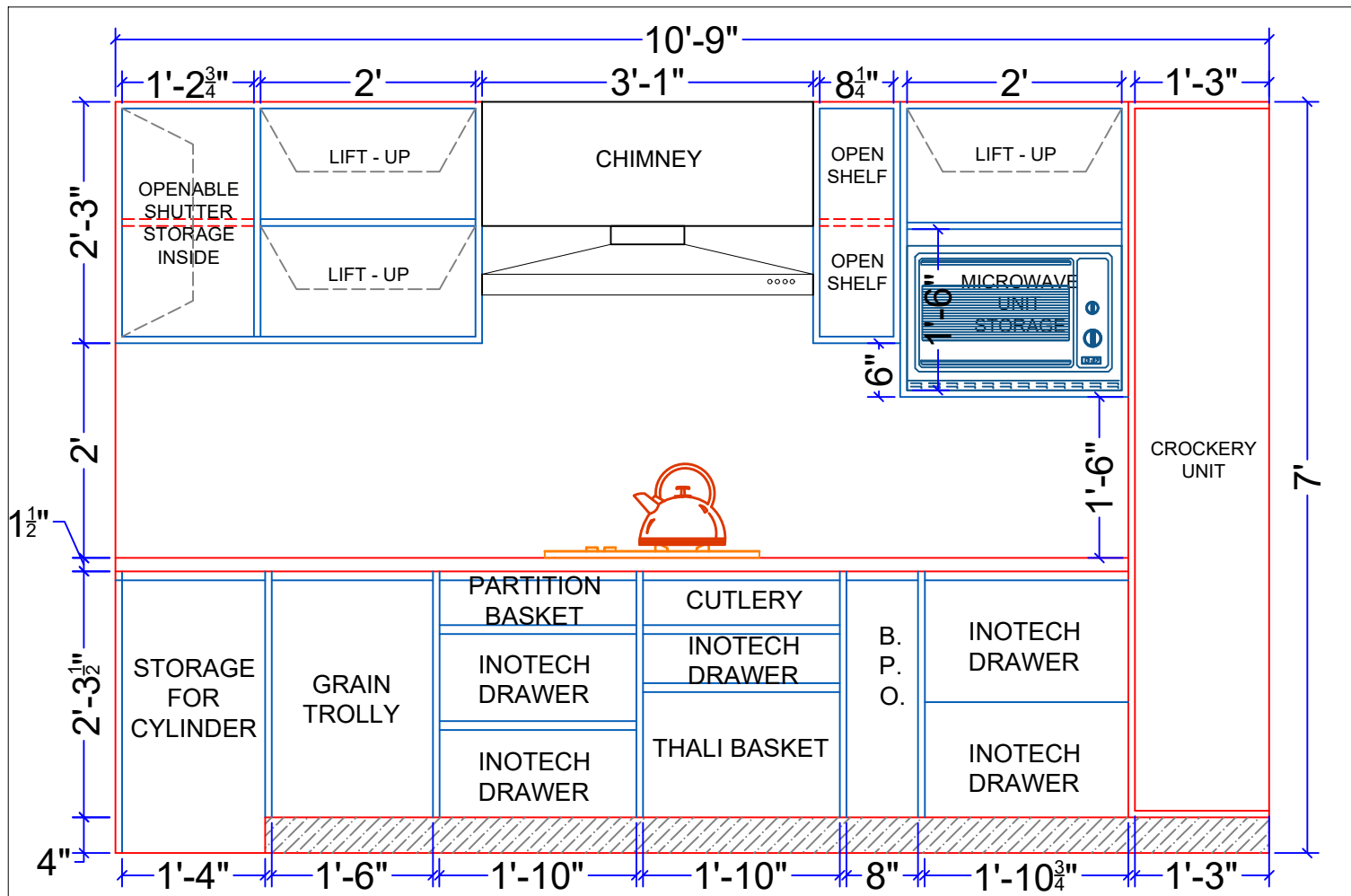

ELEVATION C

	DELUSION INTERIO PVT. LTD., GMS ROAD, DEHRADUN			
	CLIENT NAME: Mr. Rajat Ahuja	PROJECT: Proposed Residence	PROPORTION: NOT TO SCALE	

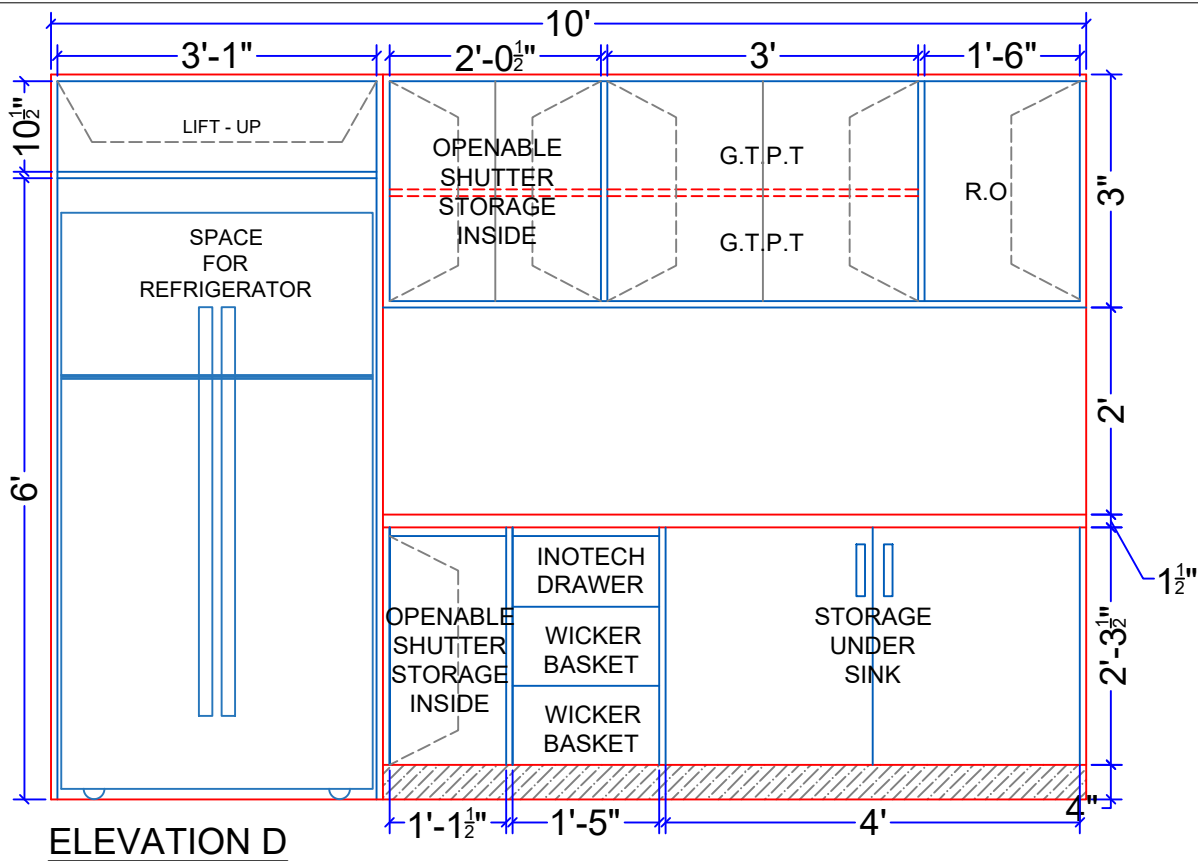

ELEVATION D

	DELUSION INTERIO PVT. LTD., GMS ROAD, DEHRADUN			
	CLIENT NAME: Mr. Rajat Ahuja	PROJECT: Proposed Residence	PROPORTION: NOT TO SCALE	



DELUSION INTERIO PVT.LTD.

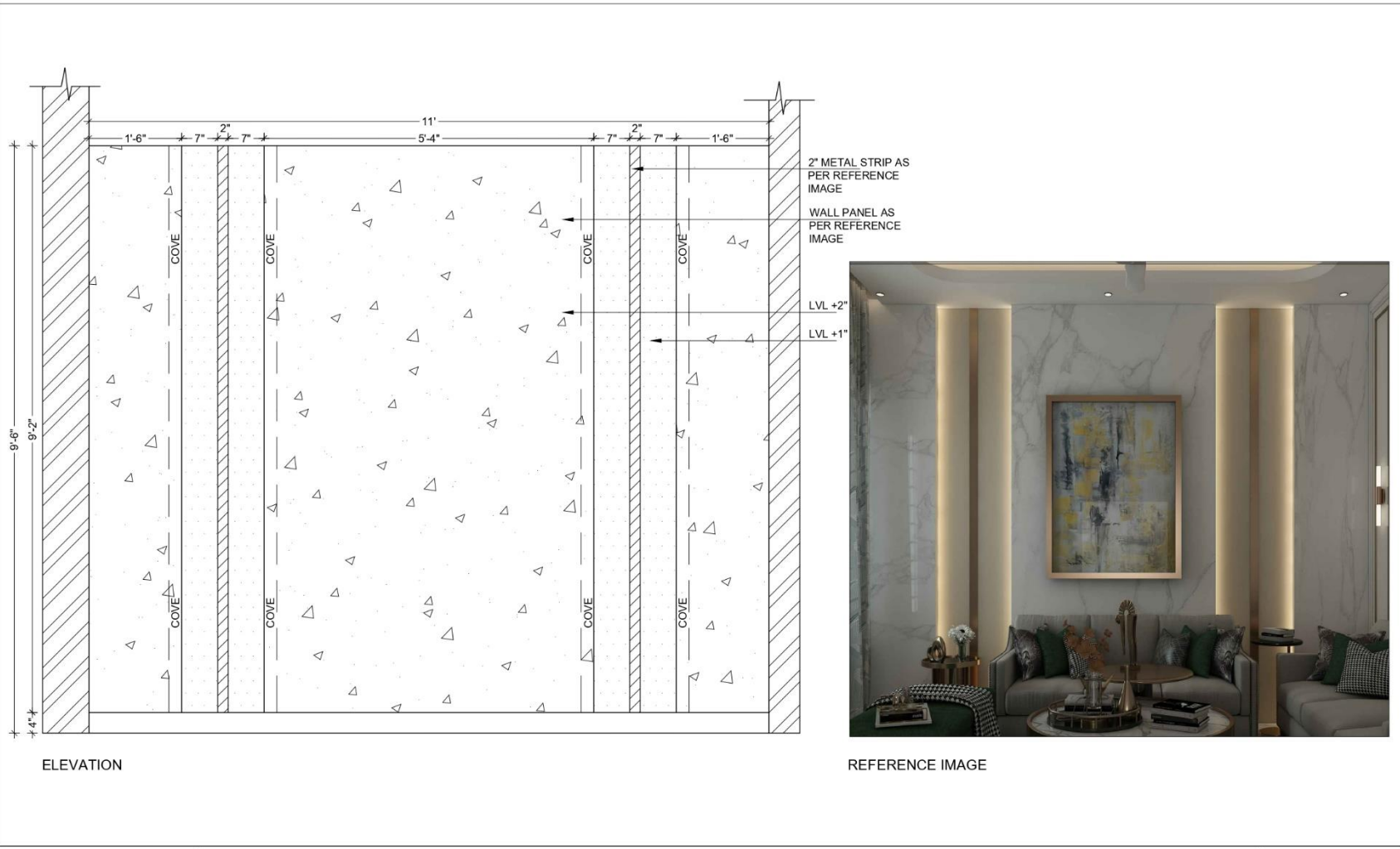



ELEVATION

REFERENCE IMAGE

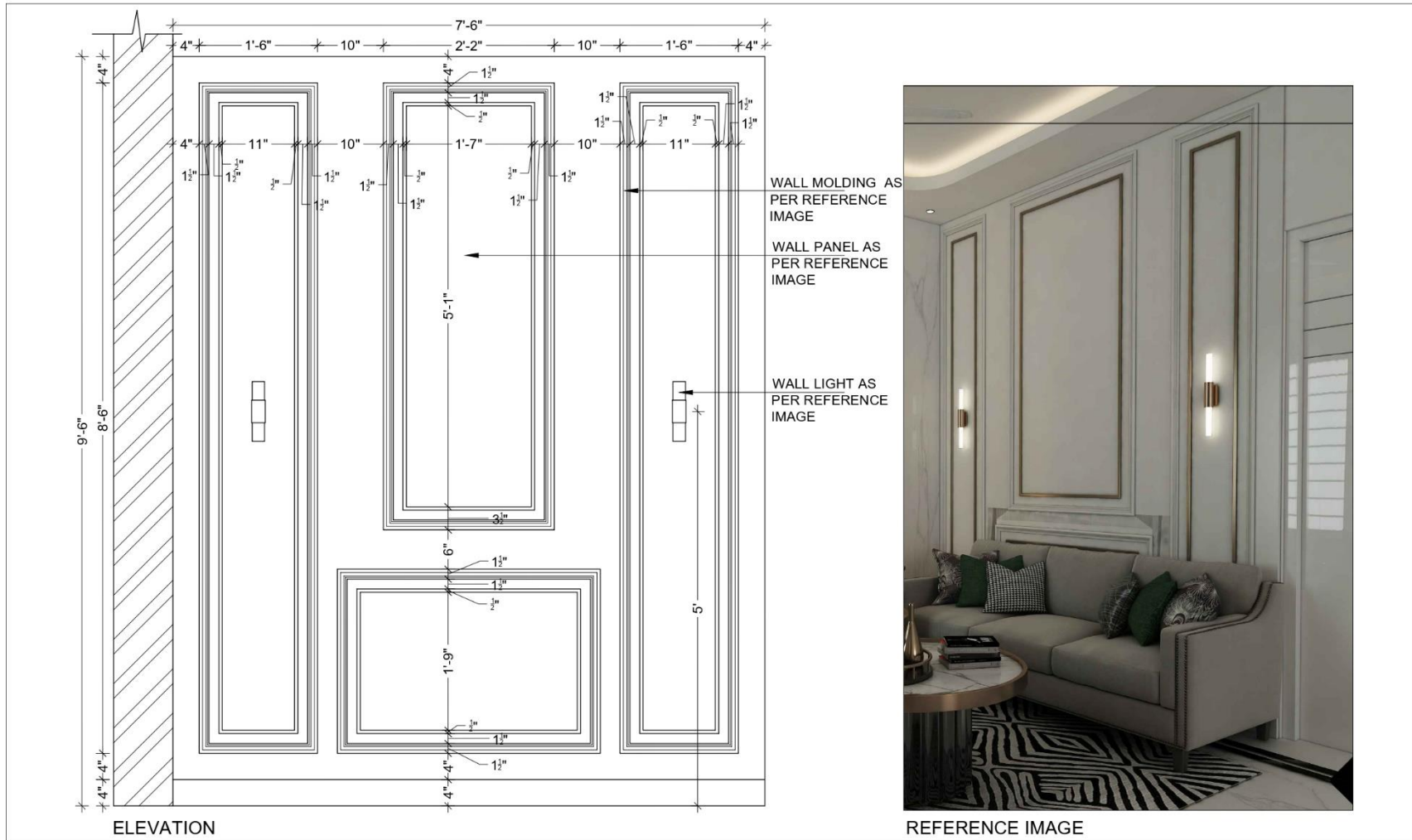
 <p>DELUSION INTERIO DESIGN DECOR DETAIL</p>	<p>DELUSION INTERIO PVT. LTD., GMS ROAD, DEHRADUN</p>			
	<p>CLIENT NAME: Mr. Rajat Ahuja</p>	<p>PROJECT: Proposed Residence</p>	<p>PROPORTION: NOT TO SCALE</p>	



 <p>DELUSION INTERIO DESIGN DECOR DETAIL</p>	<p>DELUSION INTERIO PVT. LTD., GMS ROAD, DEHRADUN</p>			
	<p>CLIENT NAME: Mr. Rajat Ahuja</p>	<p>PROJECT: Proposed Residence</p>	<p>PROPORTION: NOT TO SCALE</p>	



DELUSION INTERIO PVT. LTD.
CREATING BEAUTY & BRINGING COMFORT

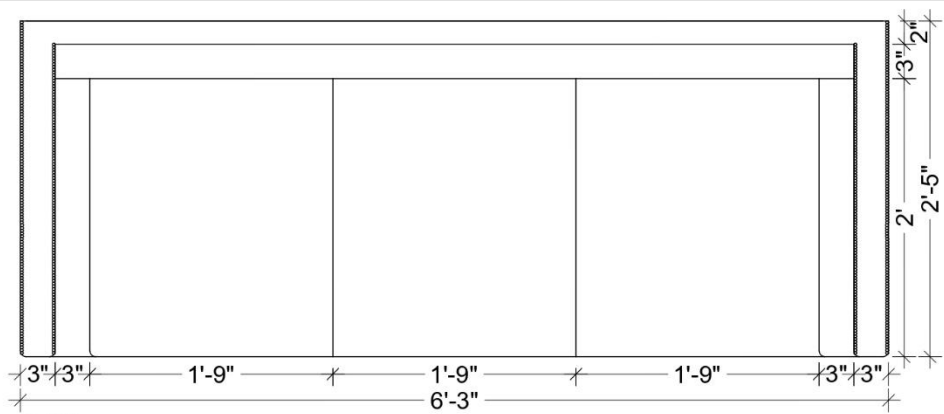

PLAN



REFERENCE IMAGE

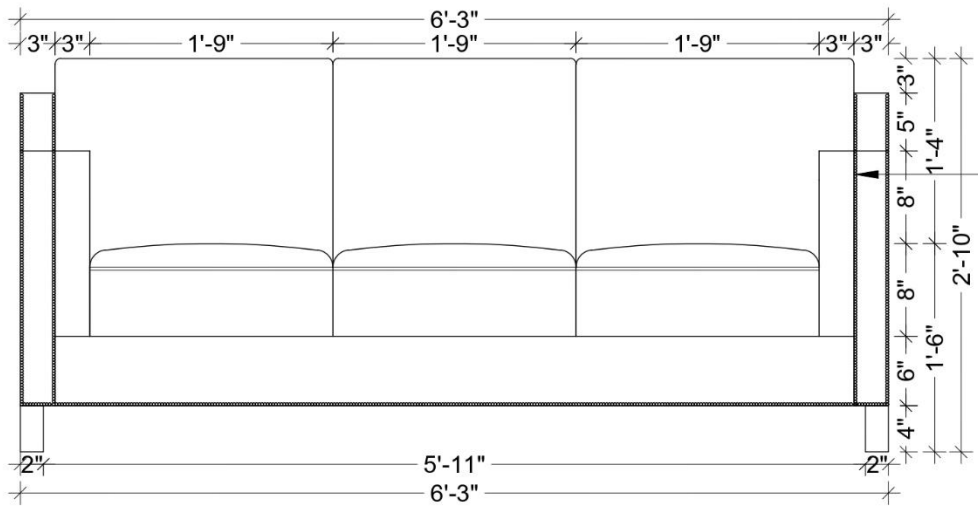

ELEVATION

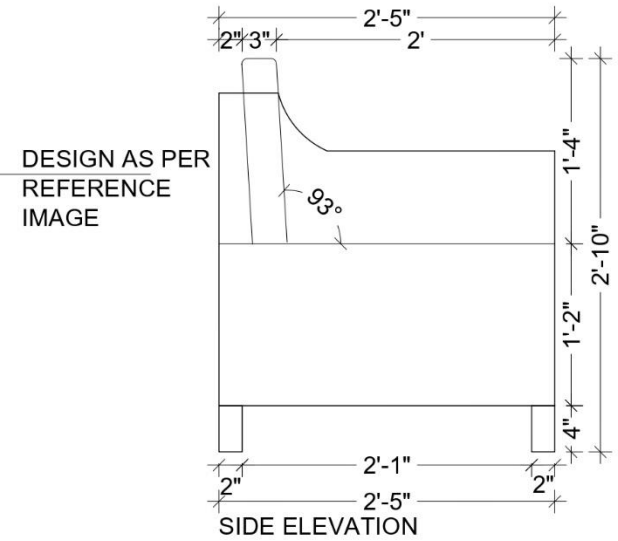

SIDE ELEVATION



DELUSION INTERIO
DESIGN | DECOR | DETAIL

DELUSION INTERIO PVT. LTD., GMS ROAD, DEHRADUN

CLIENT NAME:
Mr. Rajat Ahuja

PROJECT:
Proposed Residence

PROPORTION:
NOT TO SCALE

DRAWING:
GROUND FLOOR LIVING AREA SOFA



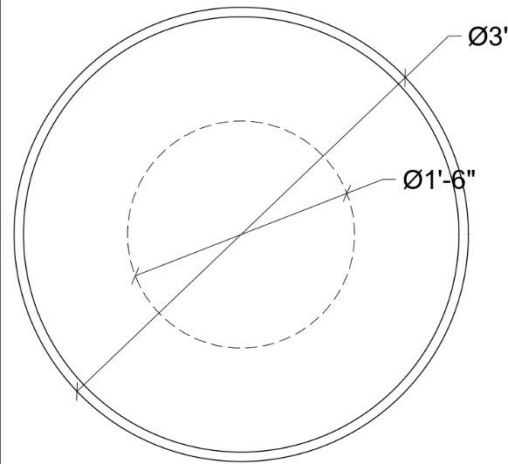

PLAN

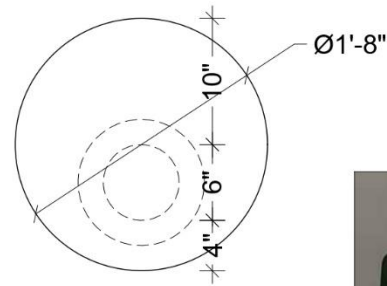

PLAN

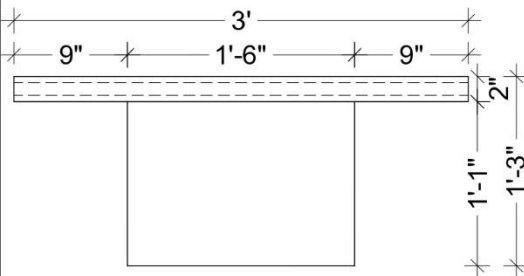

ELEVATION

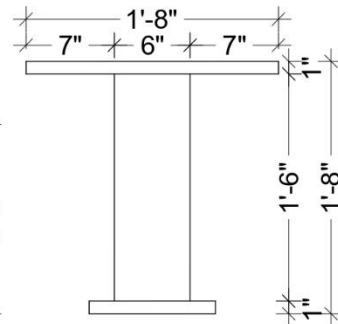

ELEVATION



REFERENCE IMAGE



DELUSION INTERIO
DESIGN | DECOR | DETAIL

DELUSION INTERIO PVT. LTD., GMS ROAD, DEHRADUN

CLIENT NAME:
Mr. Rajat Ahuja

PROJECT:
Proposed Residence

PROPORTION:
NOT TO SCALE

DRAWING:
GROUND FLOOR LIVING AREA NESTING TABLE

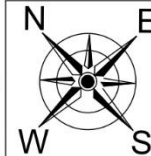

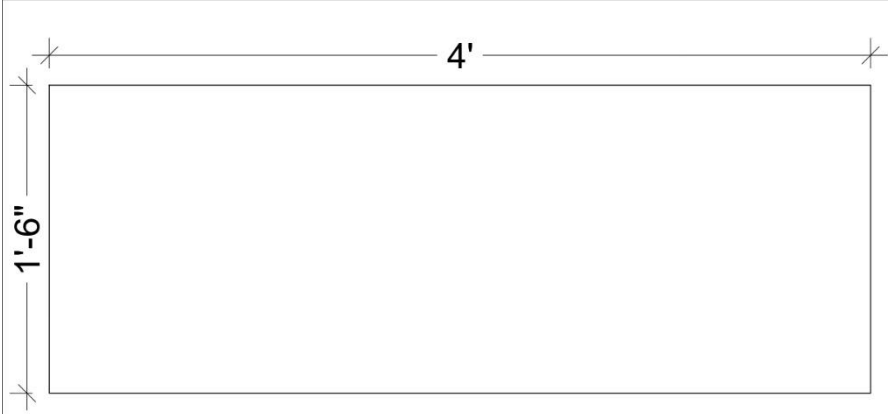

PLAN

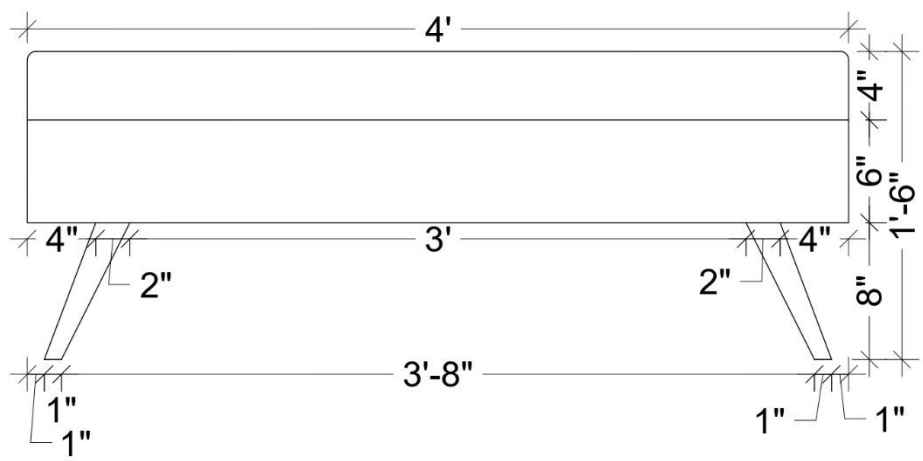

ELEVATION



REFERENCE IMAGE



DELUSION INTERIO PVT. LTD., GMS ROAD, DEHRADUN

CLIENT NAME:
Mr. Rajat Ahuja

PROJECT:
Proposed Residence

PROPORTION:
NOT TO SCALE

DRAWING:
GROUND FLOOR LIVING AREA OTTOMAN

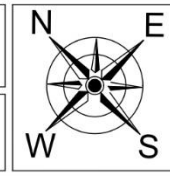



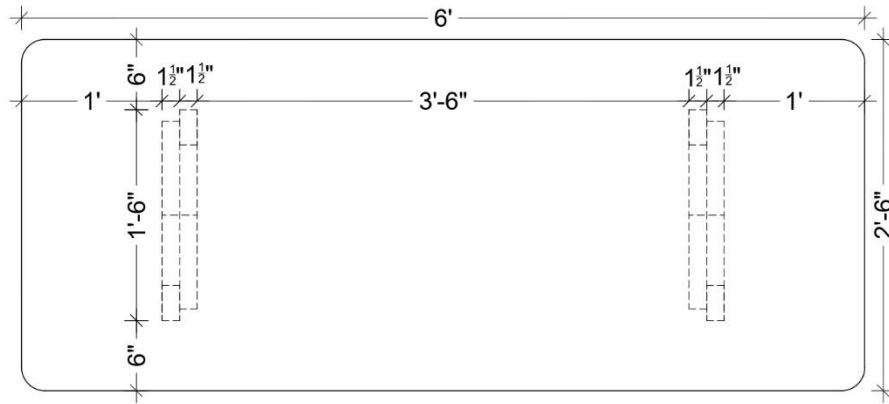

PLAN



REFERENCE IMAGE

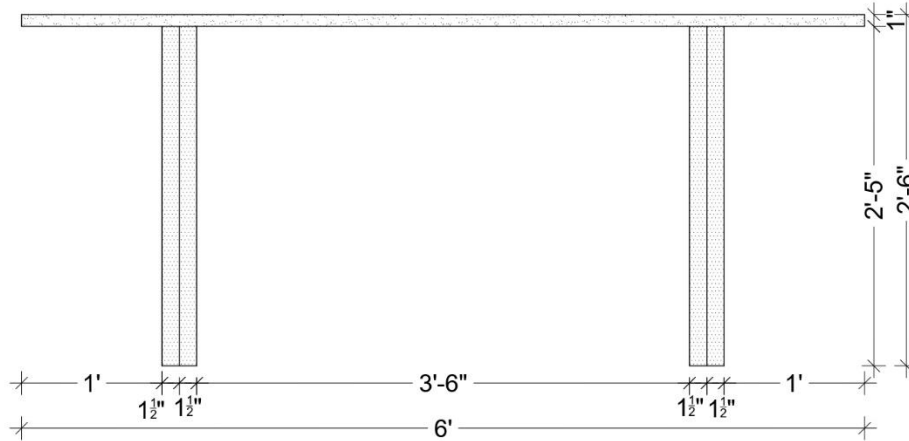

ELEVATION

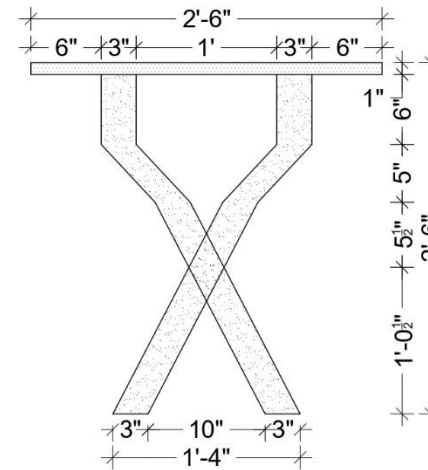

SIDE ELEVATION



DELUSION INTERIO
DESIGN | DECOR | DETAIL

DELUSION INTERIO PVT. LTD., GMS ROAD, DEHRADUN

CLIENT NAME:
Mr. Rajat Ahuja



PROJECT:
Proposed Residence

PROPORTION:
NOT TO SCALE

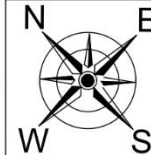
DRAWING:
GROUND FLOOR DINING TABLE

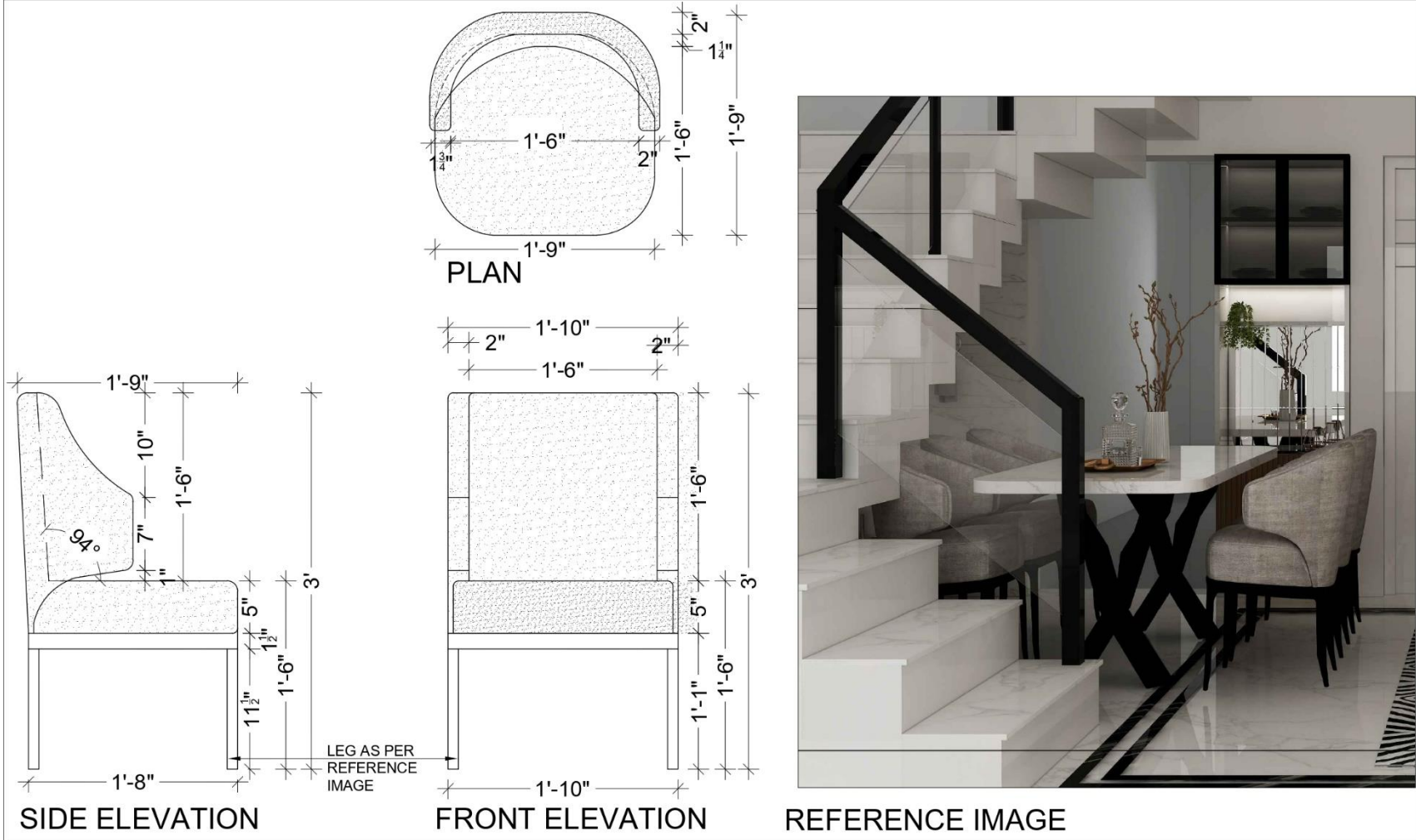



 DELUSION INTERIO <small>DESIGN DECOR DETAIL</small>	DELUSION INTERIO PVT. LTD., GMS ROAD, DEHRADUN			
	CLIENT NAME: Mr. Rajat Ahuja	PROJECT: Proposed Residence	PROPORTION: NOT TO SCALE	



DELUSION INTERIORS PVT. LTD.

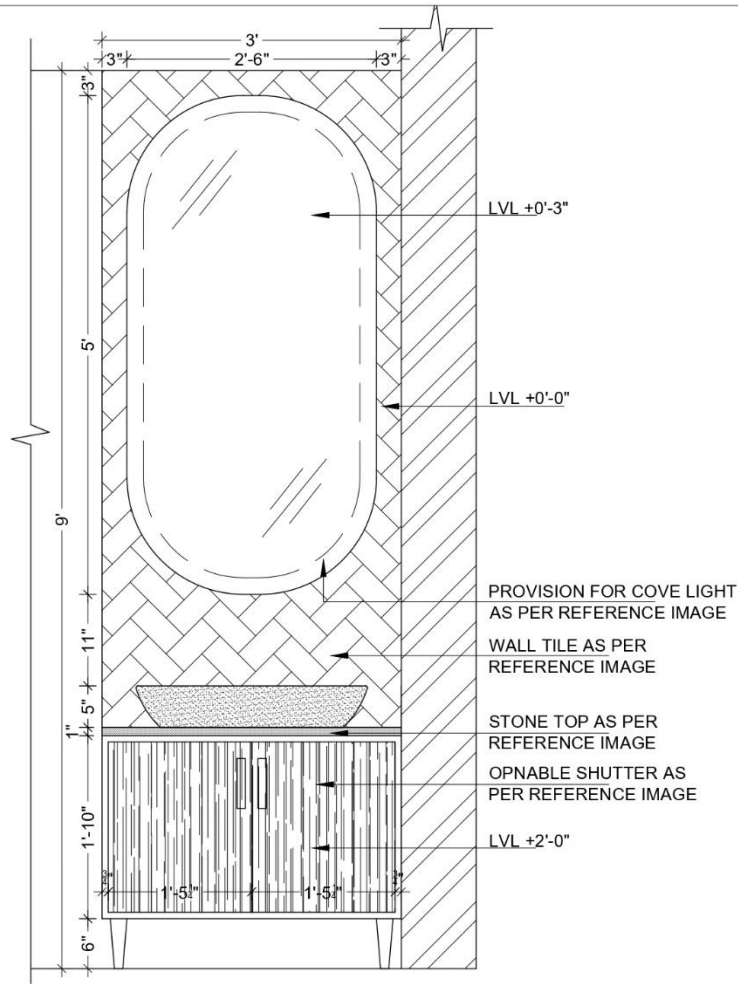

ELEVATION



REFERENCE IMAGE



DELUSION INTERIO
DESIGN | DECOR | DETAIL

DELUSION INTERIO PVT. LTD., GMS ROAD, DEHRADUN

CLIENT NAME:
Mr. Rajat Ahuja

PROJECT:
Proposed Residence

PROPORTION:
NOT TO SCALE

DRAWING:
GROUND FLOOR DINING VANITY

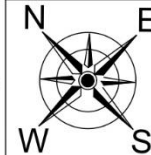

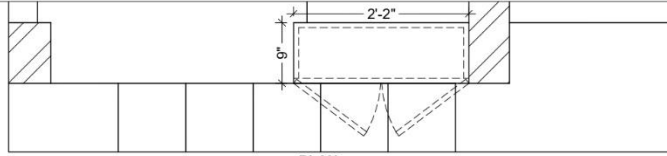

PLAN



REFERENCE IMAGE

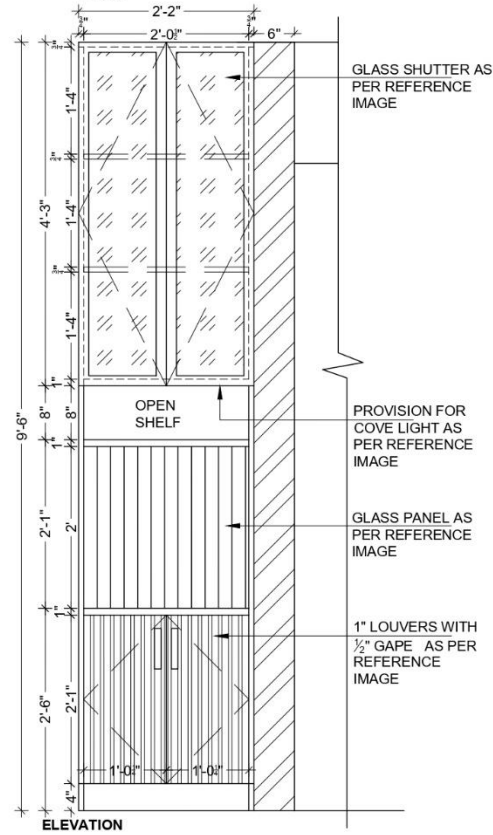

DELUSION INTERIO
DESIGN | DECOR | DETAIL

DELUSION INTERIO PVT. LTD., GMS ROAD, DEHRADUN

CLIENT NAME:
Mr. Rajat Ahuja

PROJECT:
Proposed Residence

PROPORTION:
NOT TO SCALE

DRAWING:
GROUND FLOOR DINING AREA STORAGE

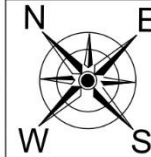



DELUSION INTERIO PVT. LTD.
CREATING BEAUTY & BRINGING COMFORT

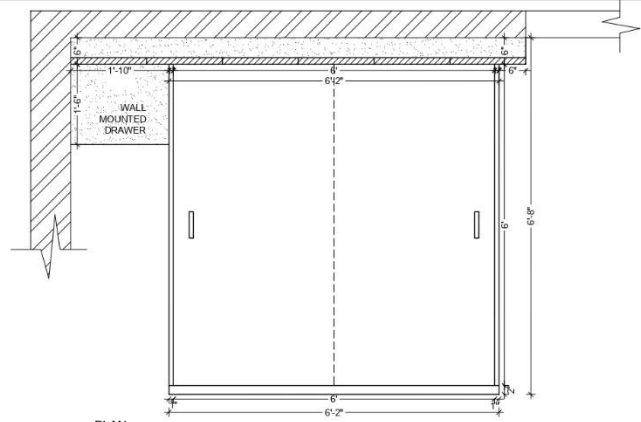

PLAN

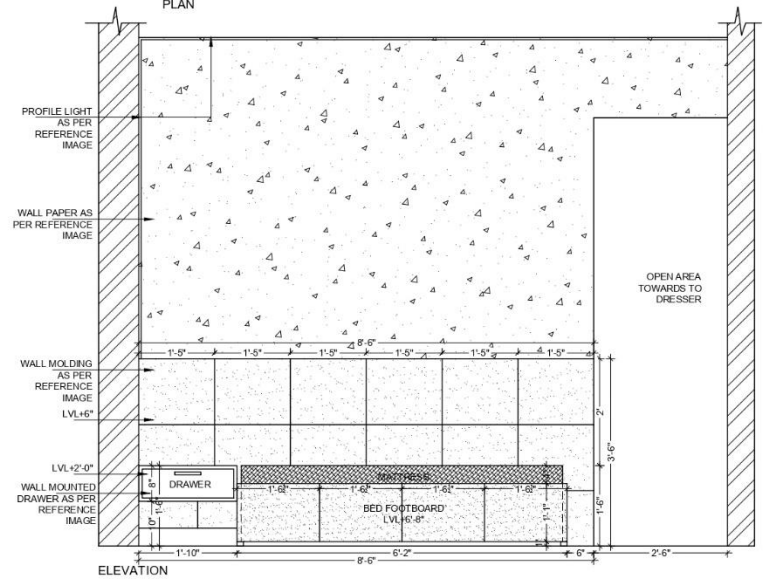

ELEVATION



REFERENCE IMAGE



DELUSION INTERIO
DESIGN | DECOR | DETAIL

DELUSION INTERIO PVT. LTD., GMS ROAD, DEHRADUN

CLIENT NAME:
Mr. Rajat Ahuja

PROJECT:
Proposed Residence

PROPORTION:
NOT TO SCALE

DRAWING:
GROUND FLOOR PARENT BEDROOM BED





DELLESON INTERIO PVT LTD.
CREATING COMFORT & BRINGING COMFORT

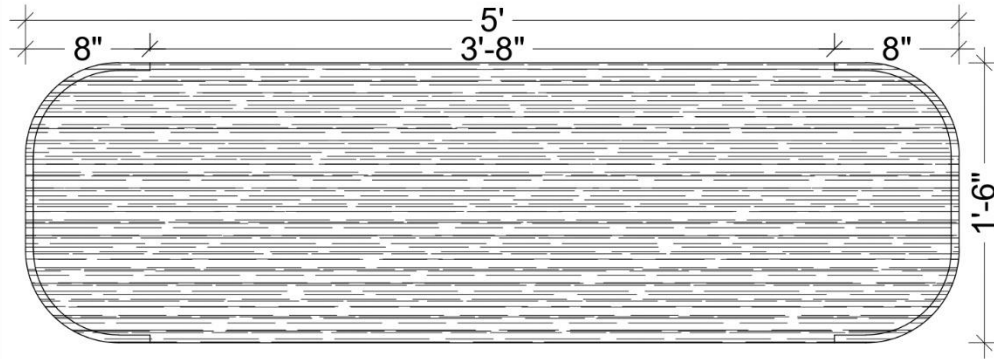

PLAN

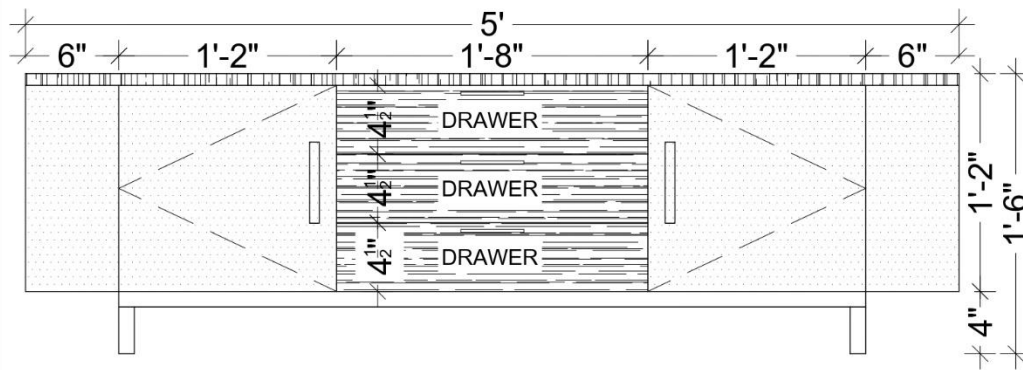

ELEVATION



REFERENCE IMAGE



DELUSION INTERIO
DESIGN | DECOR | DETAIL

DELUSION INTERIO PVT. LTD., GMS ROAD, DEHRADUN

CLIENT NAME:
Mr. Rajat Ahuja

PROJECT:
Proposed Residence

PROPORTION:
NOT TO SCALE

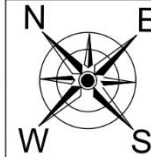

DRAWING:
GROUND FLOOR PARENT BED ROOM TV UNIT



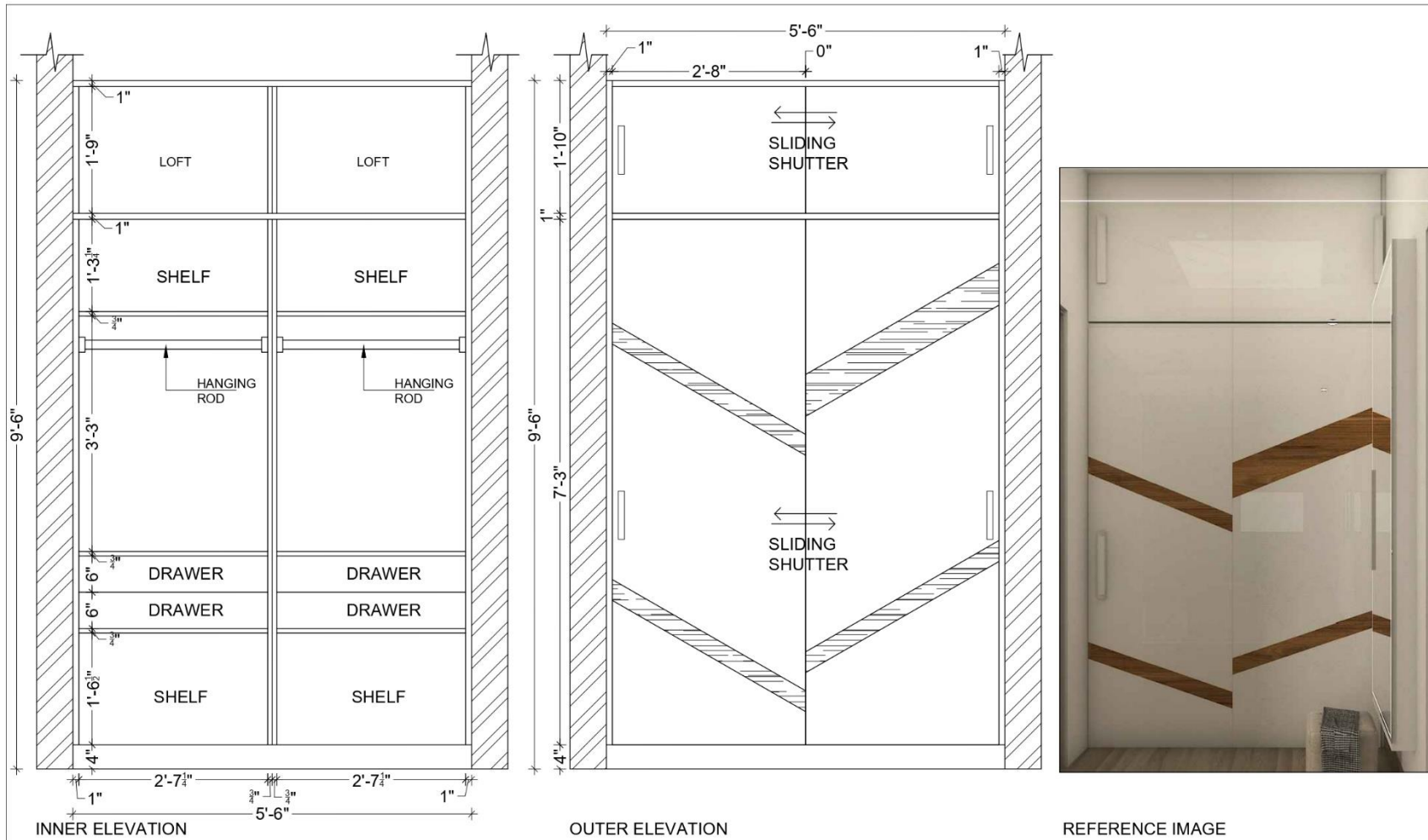

DELUSION INTERIO PVT. LTD.
CREATING BEAUTY & BRINGING COMFORT



 <p>DELUSION INTERIO DESIGN DECOR DETAIL</p>	<p>DELUSION INTERIO PVT. LTD., GMS ROAD, DEHRADUN</p>			
	<p>CLIENT NAME: Mr. Rajat Ahuja</p>	<p>PROJECT: Proposed Residence</p>	<p>PROPORTION: NOT TO SCALE</p>	



DELUSION INTERIO PVT.LTD.
CREATING BEAUTY & BRINGING COMFORT

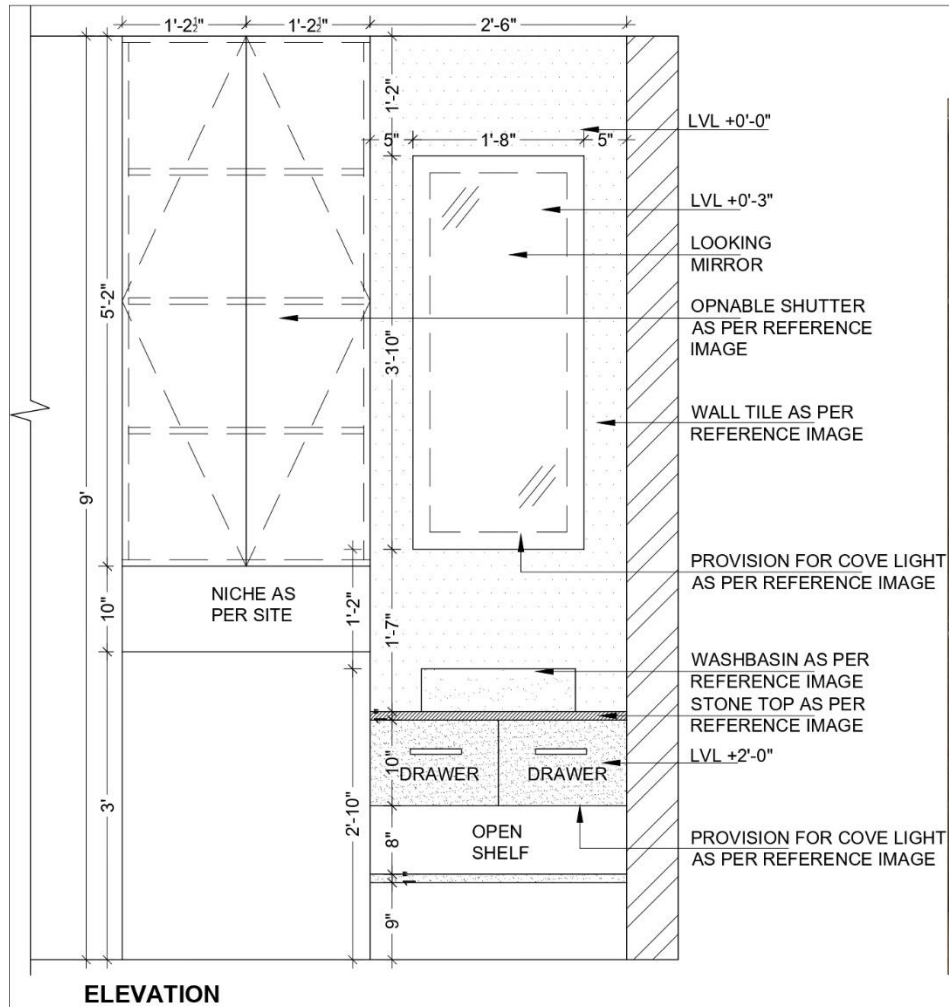

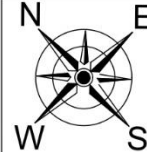

 <p>DELUSION INTERIO DESIGN DECOR DETAIL</p>	<p>DELUSION INTERIO PVT. LTD., GMS ROAD, DEHRADUN</p>			
	<p>CLIENT NAME: Mr. Rajat Ahuja</p>	<p>PROJECT: Proposed Residence</p>	<p>PROPORTION: NOT TO SCALE</p>	

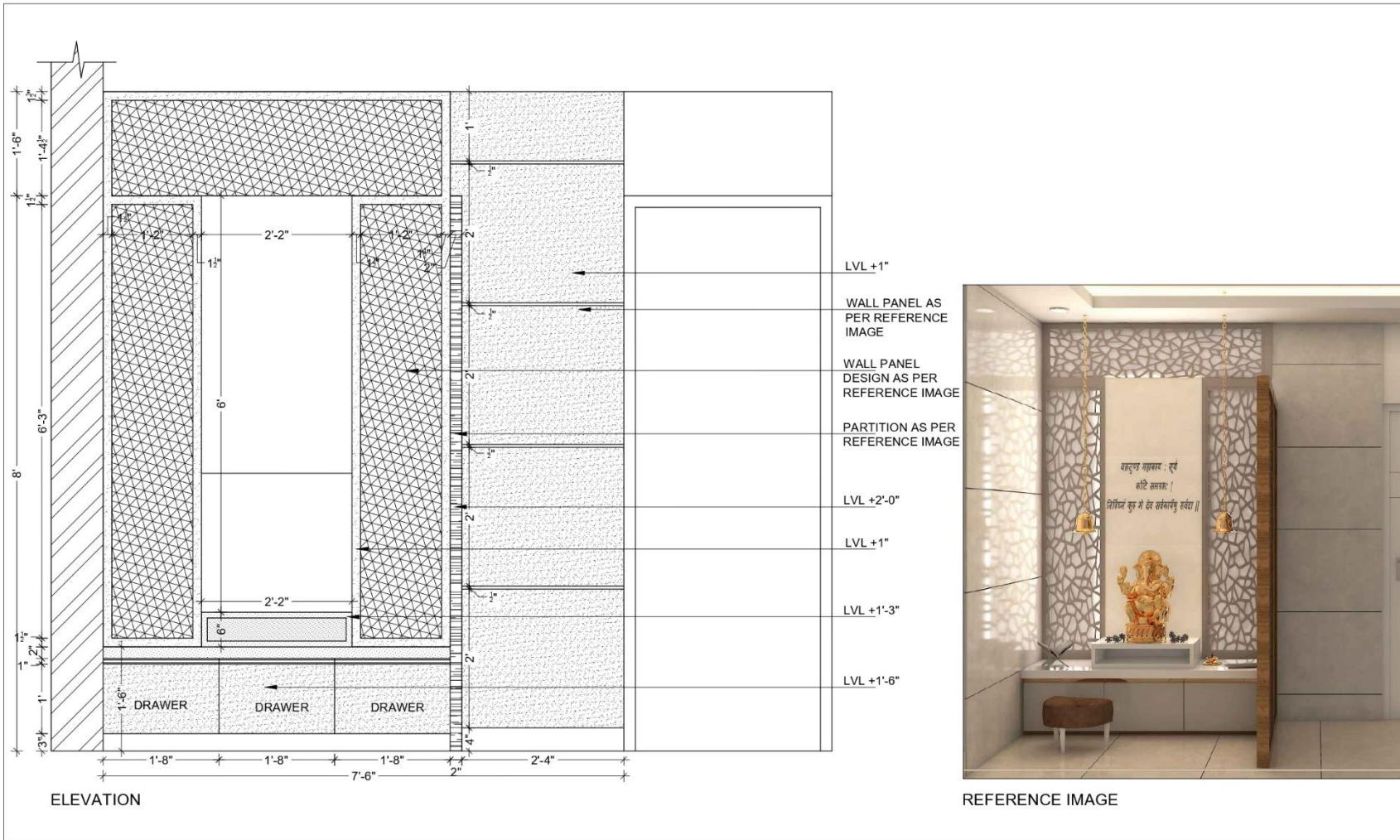

DELUSION INTERIO PVT. LTD.
CREATING BEAUTY & BRINGING COMFORT



 <p>DELUSION INTERIO DESIGN DECOR DETAIL</p>	<p>DELUSION INTERIO PVT. LTD., GMS ROAD, DEHRADUN</p>			
	<p>CLIENT NAME: Mr. Rajat Ahuja</p>	<p>PROJECT: Proposed Residence</p>	<p>PROPORTION: NOT TO SCALE</p>	







Forever
Young

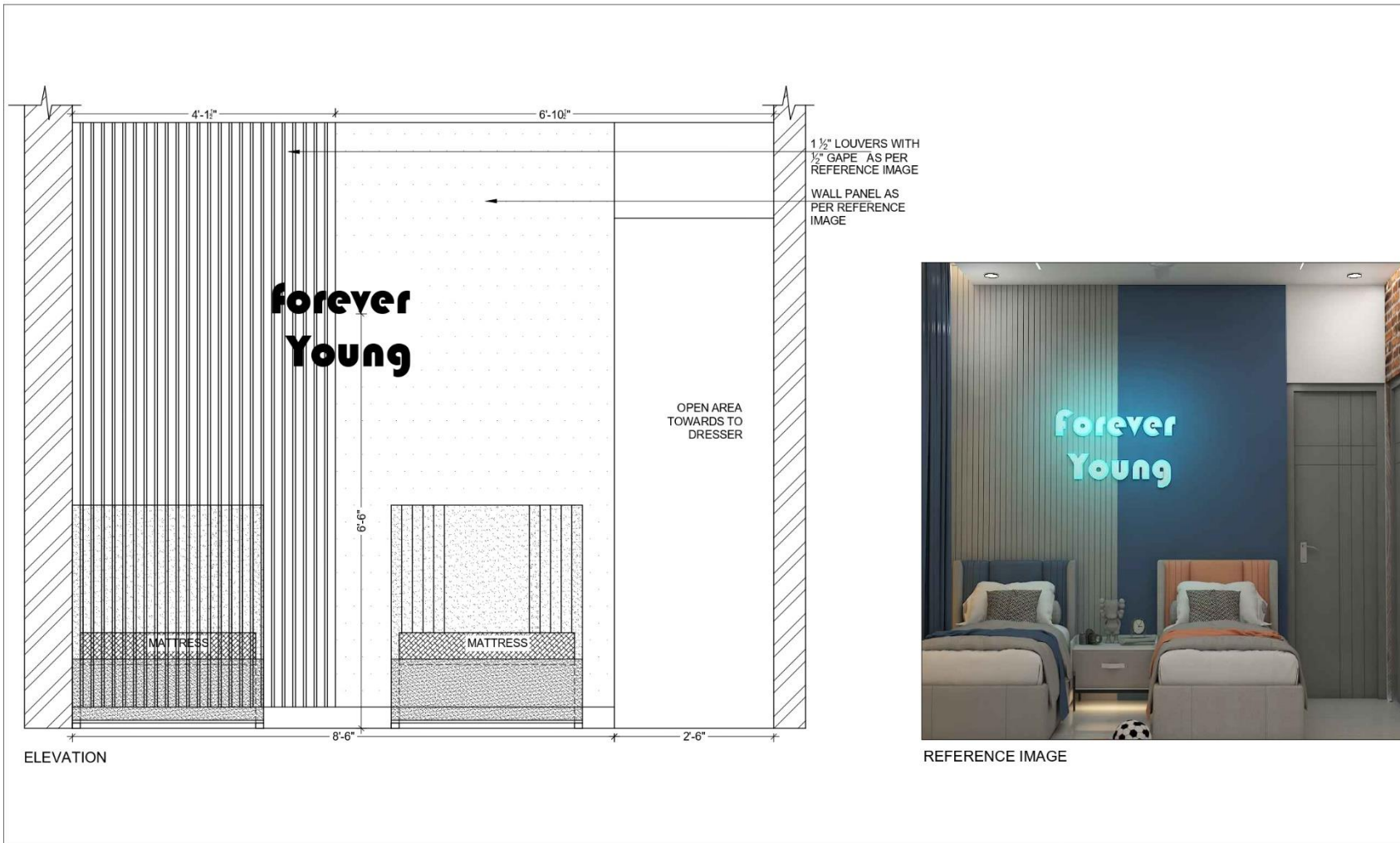

DELUSION INTERIO PVT. LTD.
CREATING BEAUTY BY BRINGING COMFORT



 <p>DELUSION INTERIO DESIGN DECOR DETAIL</p>	<p>DELUSION INTERIO PVT. LTD., GMS ROAD, DEHRADUN</p>			
	<p>CLIENT NAME: Mr. Rajat Ahuja</p>	<p>PROJECT: Proposed Residence</p>	<p>PROPORTION: NOT TO SCALE</p>	

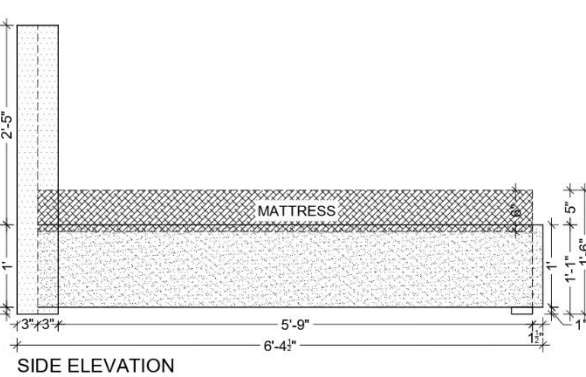
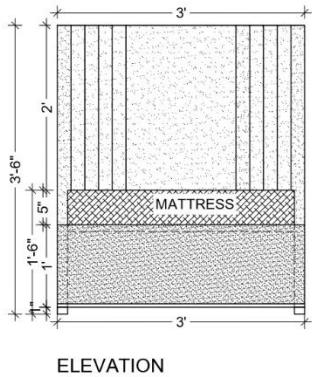
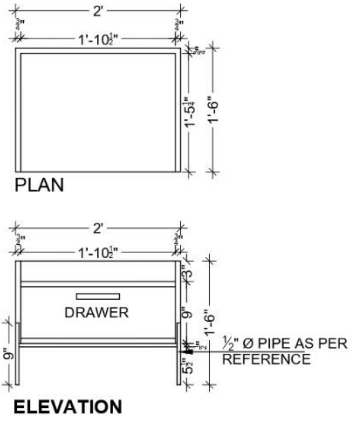
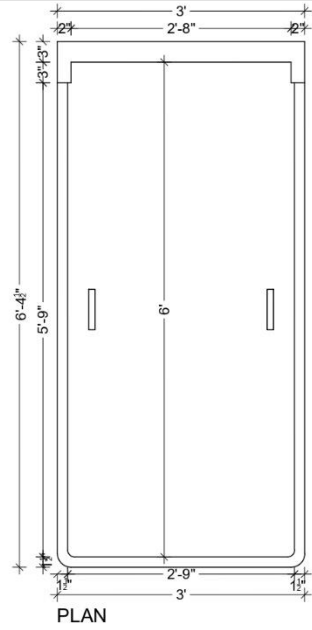

REFERENCE IMAGE



DELUSION INTERIO
DESIGN | DECOR | DETAIL

DELUSION INTERIO PVT. LTD., GMS ROAD, DEHRADUN

CLIENT NAME:
Mr. Rajat Ahuja

PROJECT:
Proposed Residence

PROPORTION:
NOT TO SCALE

DRAWING:
FIRST FLOOR KIDS BEDROOM BED&SIDE TABLE

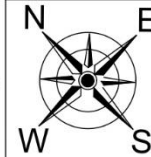





DELUSION INTERIO PVT.LTD.
CREATING BEAUTY & BRINGING COMFORT

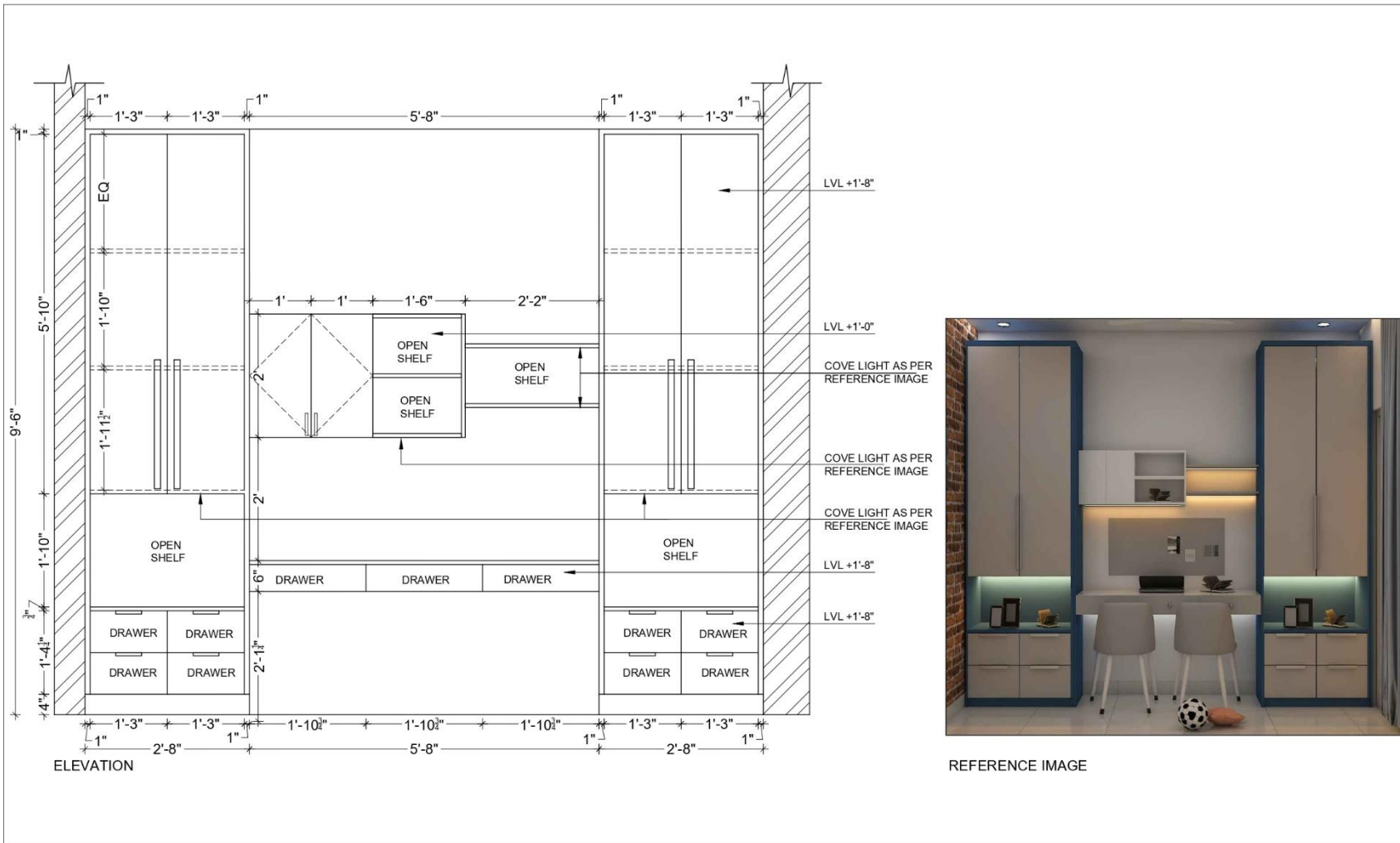

DELUSION INTERIO PVT. LTD.
CREATING BEAUTY & BRINGING COMFORT





 <p>DELUSION INTERIO DESIGN DECOR DETAIL</p>	<p>DELUSION INTERIO PVT. LTD., GMS ROAD, DEHRADUN</p>			
	<p>CLIENT NAME: Mr. Rajat Ahuja</p>	<p>PROJECT: Proposed Residence</p>	<p>PROPORTION: NOT TO SCALE</p>	

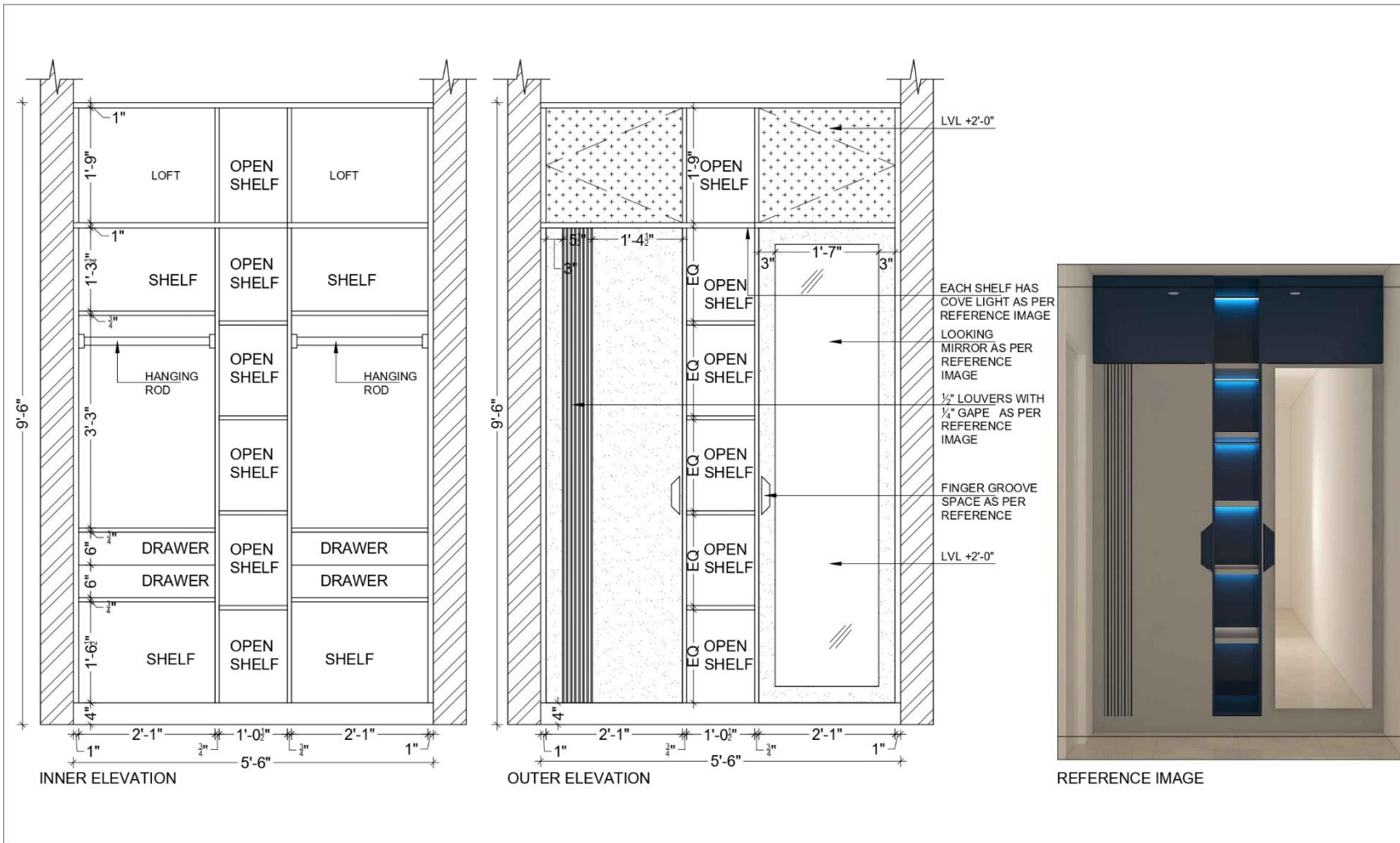

DELUSION INTERIO PVT.LTD.
CREATING BEAUTY & BRINGING COMFORT



 <p>DELUSION INTERIO DESIGN DECOR DETAIL</p>	<p>DELUSION INTERIO PVT. LTD., GMS ROAD, DEHRADUN</p>			
	<p>CLIENT NAME: Mr. Rajat Ahuja</p>	<p>PROJECT: Proposed Residence</p>	<p>PROPORTION: NOT TO SCALE</p>	



DELUSION INTERIO
DESIGN | DECOR | DETAIL

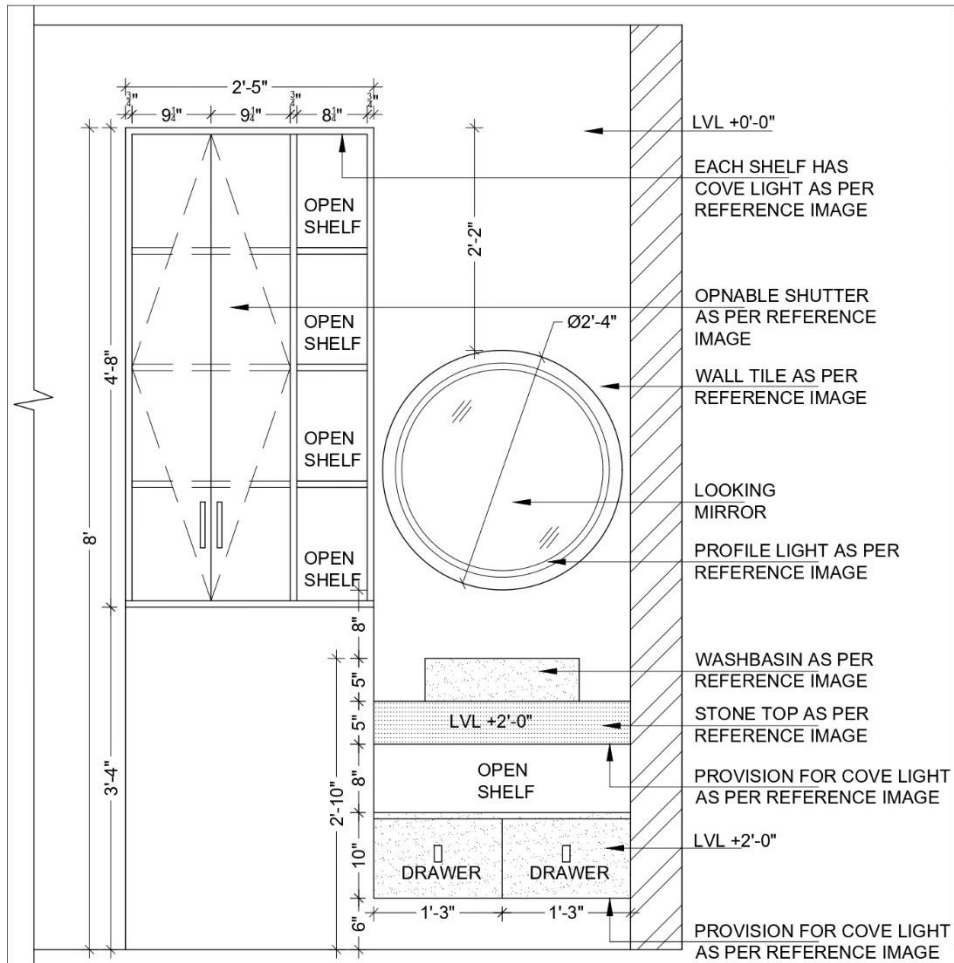

ELEVATION

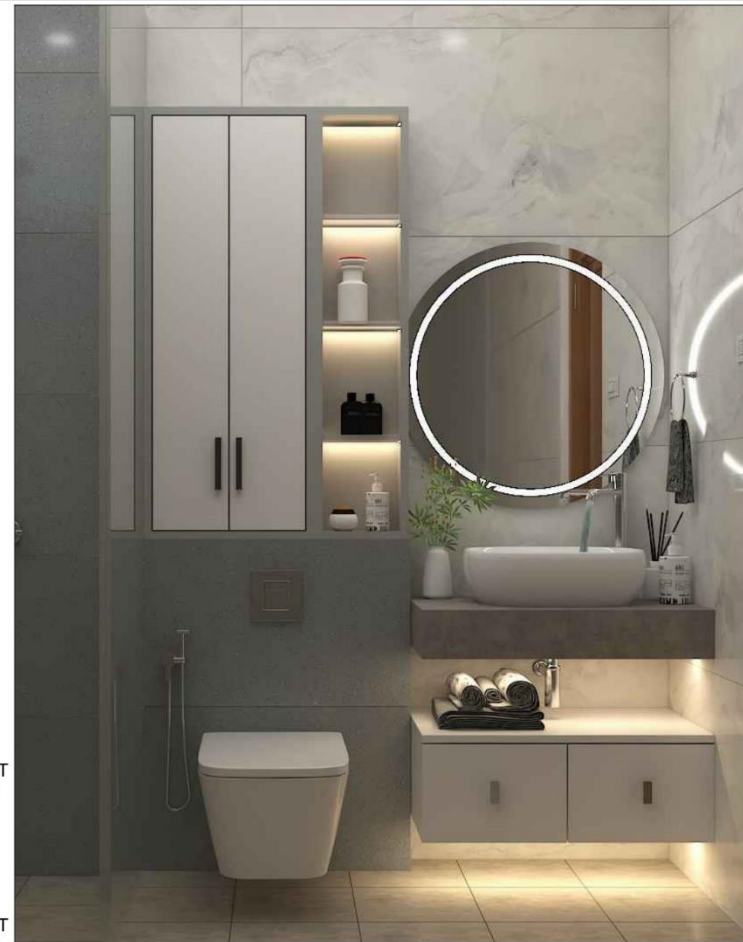

REFERENCE IMAGE



DELUSION INTERIO
DESIGN | DECOR | DETAIL

DELUSION INTERIO PVT. LTD., GMS ROAD, DEHRADUN

CLIENT NAME:
Mr. Rajat Ahuja

PROJECT:
Proposed Residence

PROPORTION:
NOT TO SCALE

DRAWING:
FIRST FLOOR KIDS ROOM VANITY

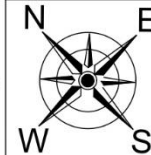



DELUSION INTERIO PVT.LTD.
CREATING BEAUTY & BRINGING COMFORT



DELUSION INTERIO
DESIGN | DECOR | DETAIL

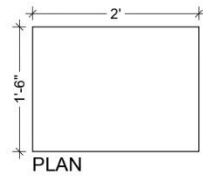
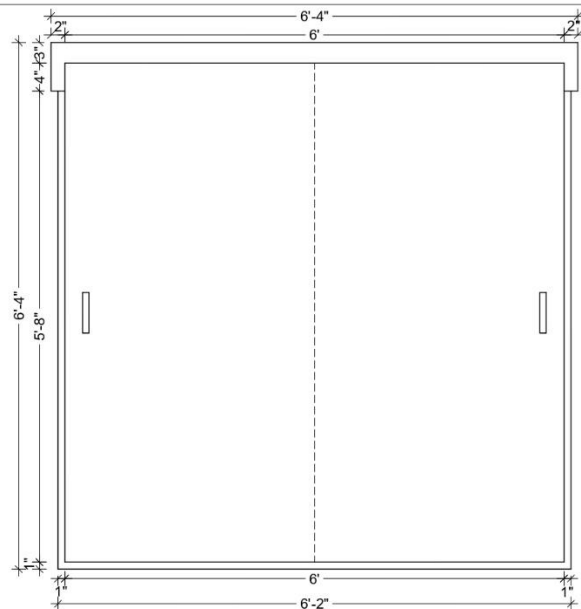

PLAN



REFERENCE IMAGE

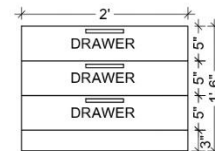

ELEVATION

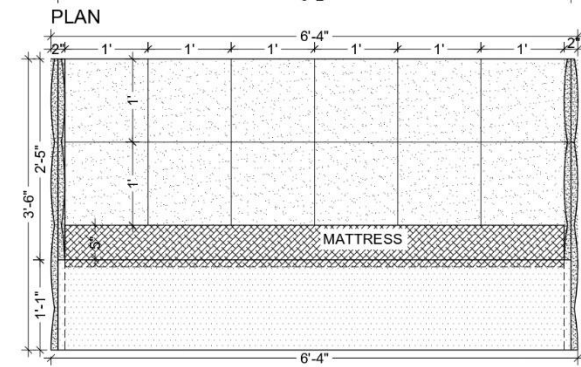

ELEVATION

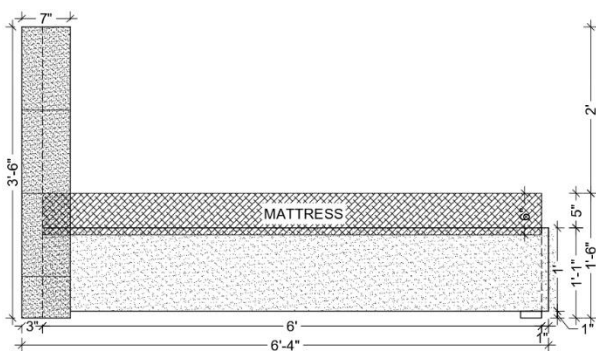

SIDE ELEVATION



DELUSION INTERIO
DESIGN | DECOR | DETAIL

DELUSION INTERIO PVT. LTD., GMS ROAD, DEHRADUN

CLIENT NAME:
Mr. Rajat Ahuja

PROJECT:
Proposed Residence

PROPORTION:
NOT TO SCALE

DRAWING:
FIRST FLOOR MASTER BEDROOM BEDBACK WALL PANEL



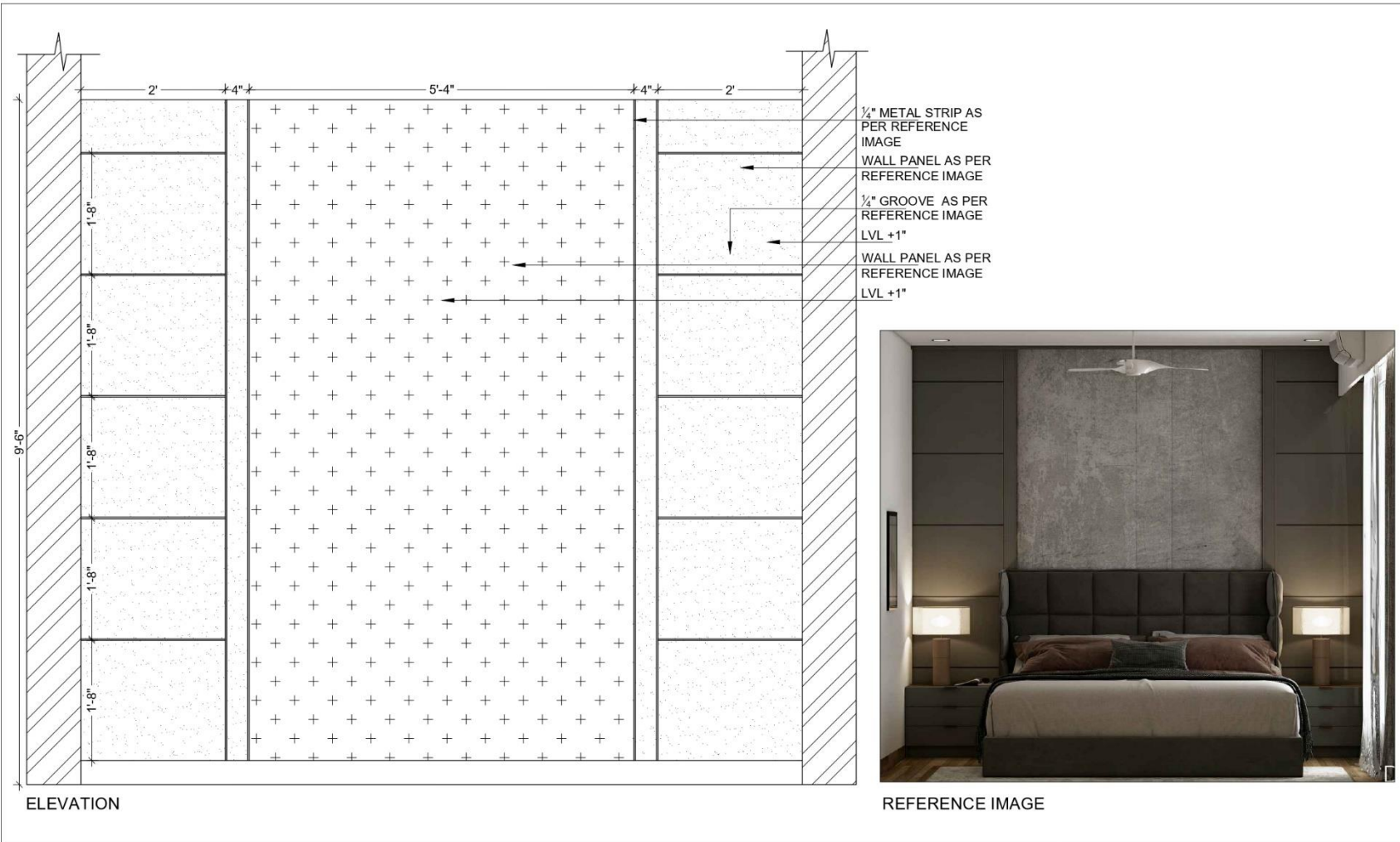

DELUSION INTERIO PVT. LTD., GMS ROAD, DEHRADUN

CLIENT NAME:
Mr. Rajat Ahuja

PROJECT:
Proposed Residence

PROPORTION:
NOT TO SCALE

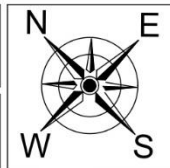

DRAWING:
FIRST FLOOR MASTER BEDROOM BEDBACK WALL PANEL



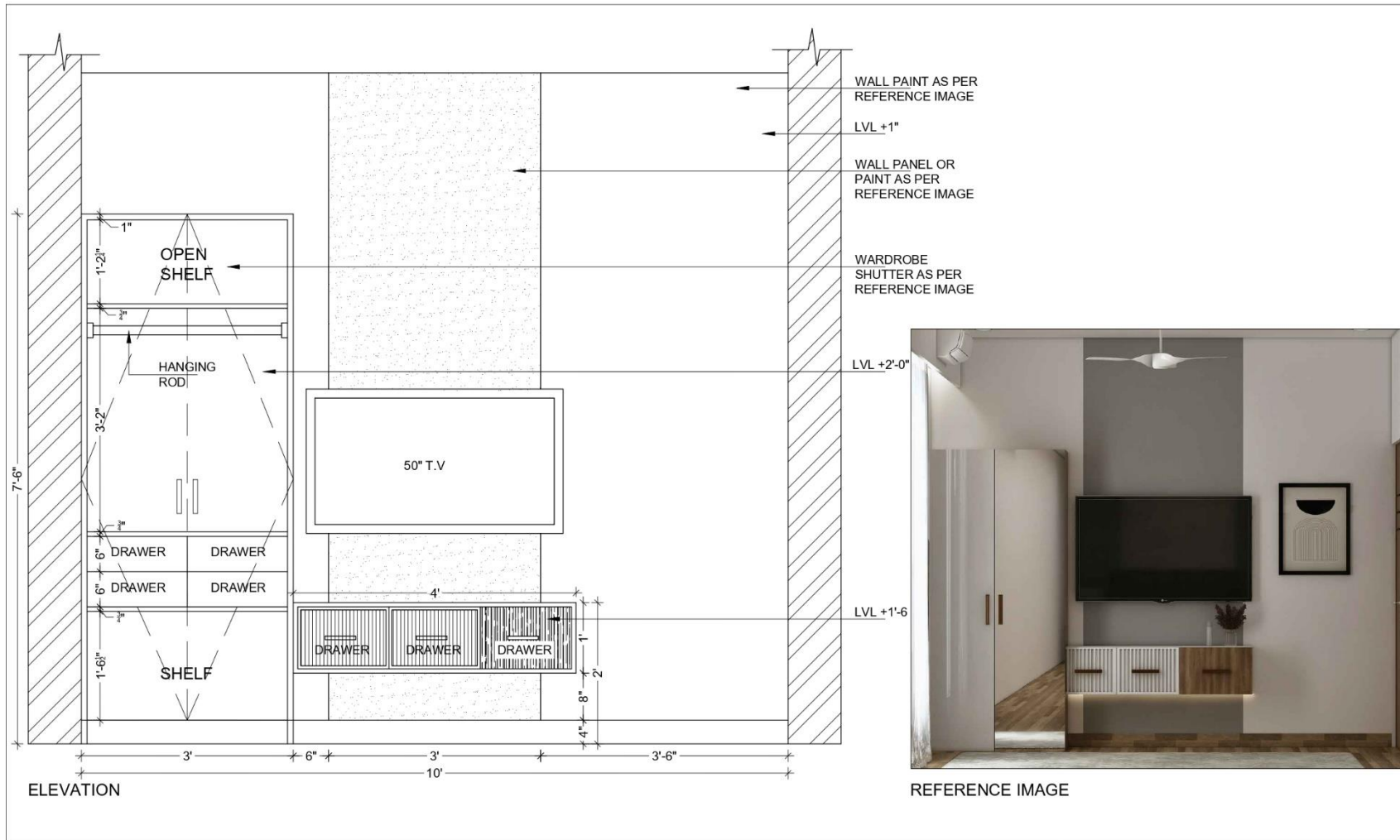

DELUSION INTERIO
DESIGN | DECOR | DETAIL



 <p>DELUSION INTERIO DESIGN DECOR DETAIL</p>	<p>DELUSION INTERIO PVT. LTD., GMS ROAD, DEHRADUN</p>			
	<p>CLIENT NAME: Mr. Rajat Ahuja</p>	<p>PROJECT: Proposed Residence</p>	<p>PROPORTION: NOT TO SCALE</p>	







The drinks are on US



DELUSION INTERIO

DESIGN | DECOR | DETAIL



DELUSION INTERIO

DESIGN | DECOR | DETAIL

*HAPPY
PLACE*

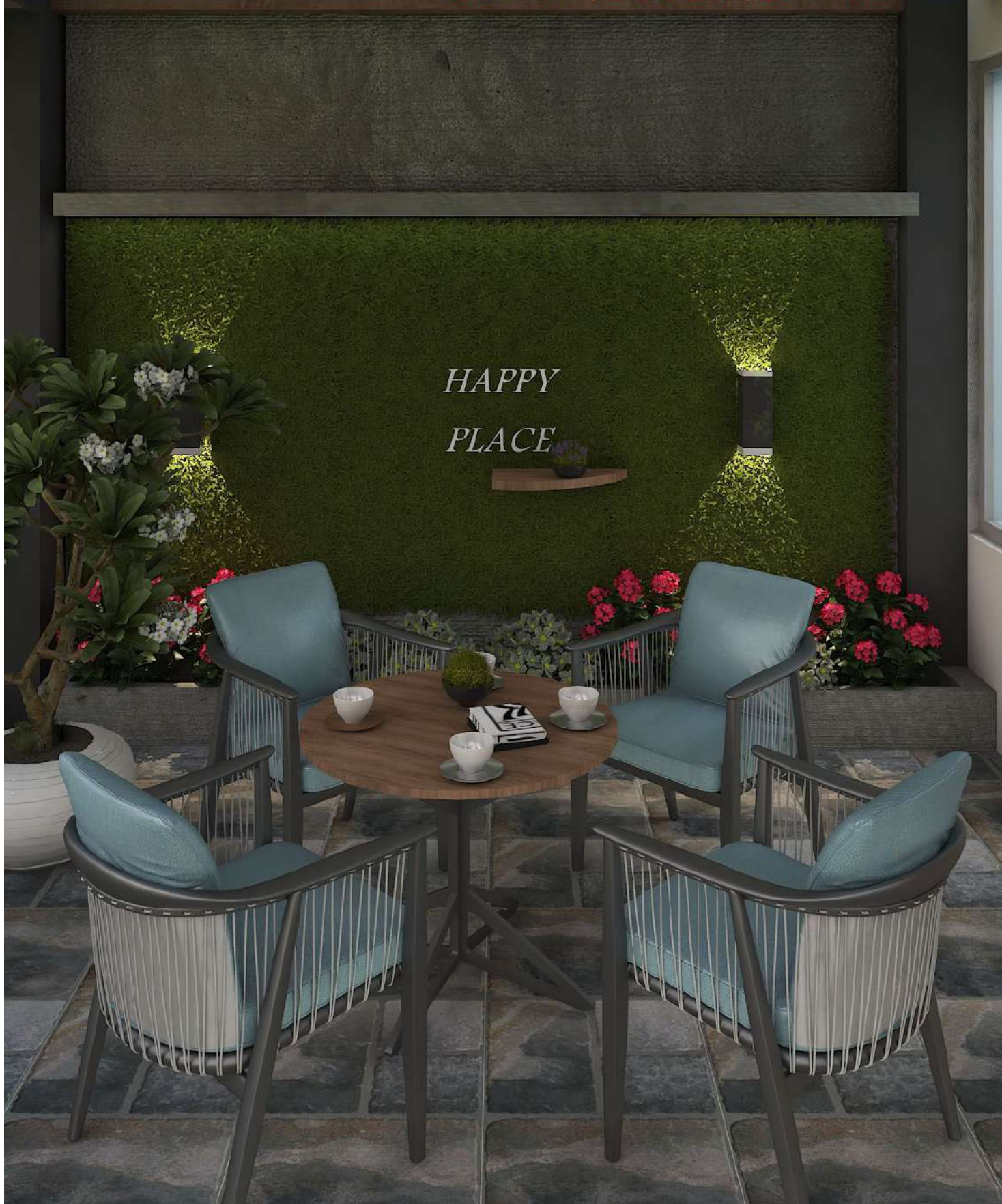

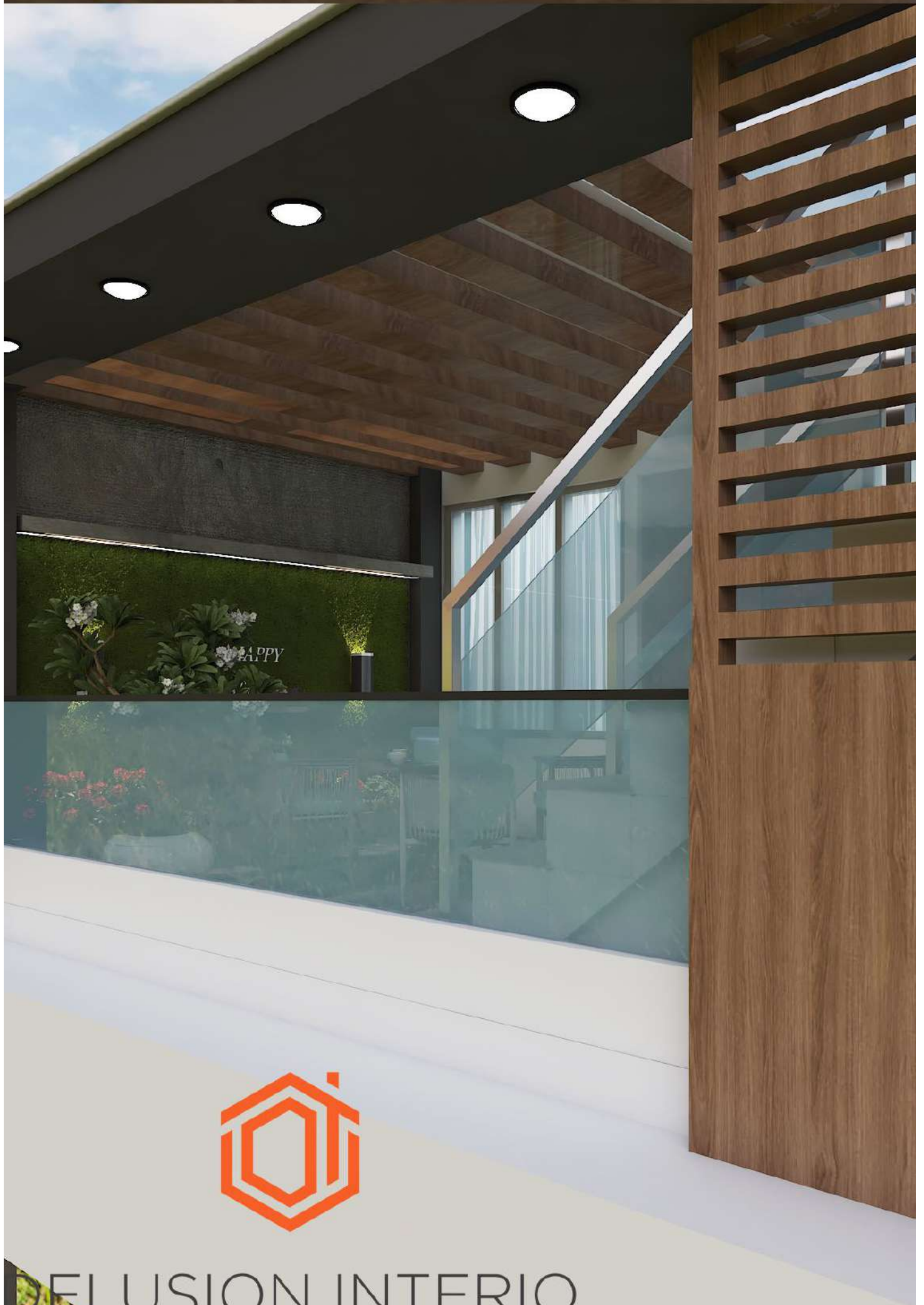

DELUSION INTERIO

DESIGN | DECOR | DETAIL

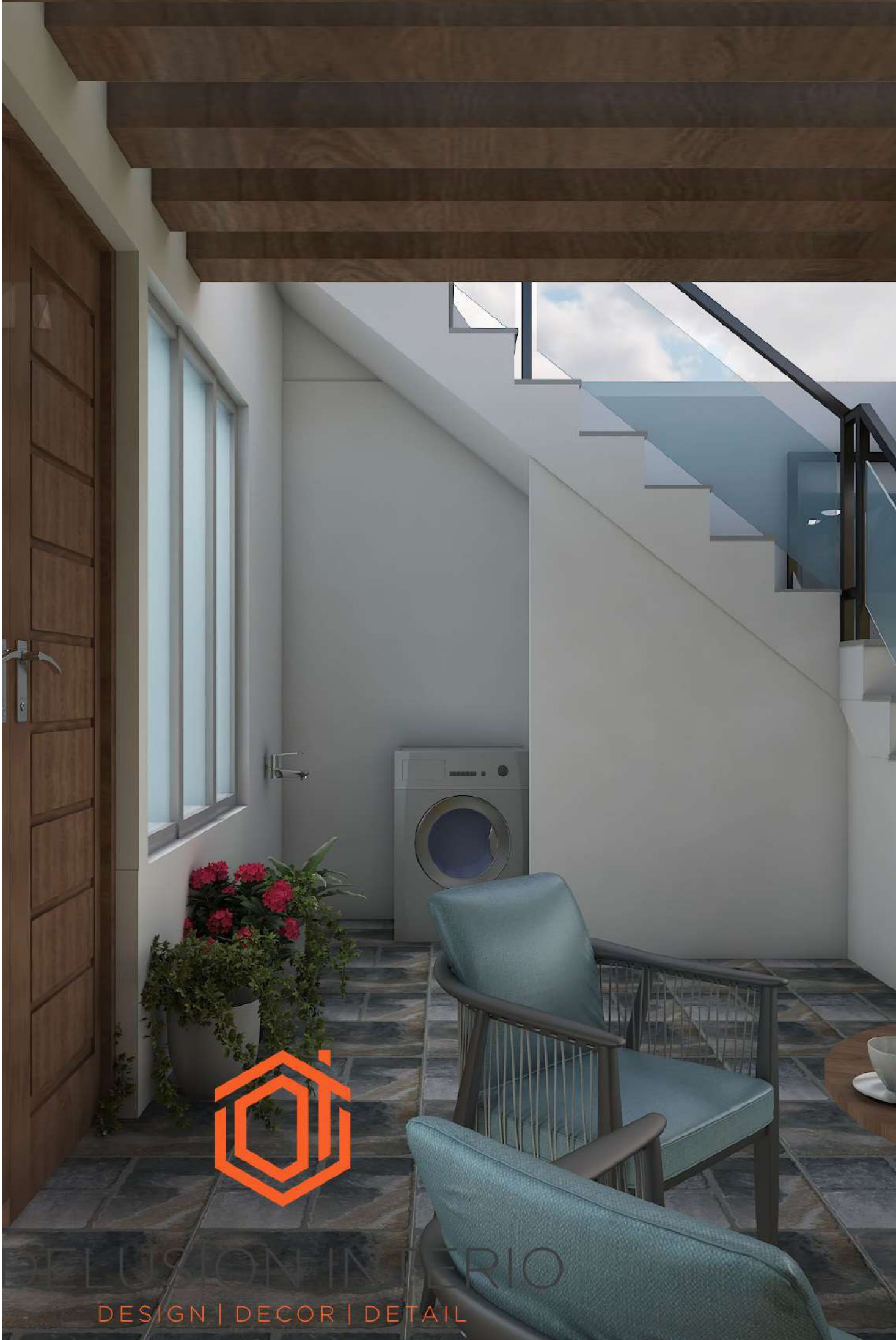

FUSION INTERIO
DESIGN | DECOR | DETAIL



*HAPPY
PLACE*

